

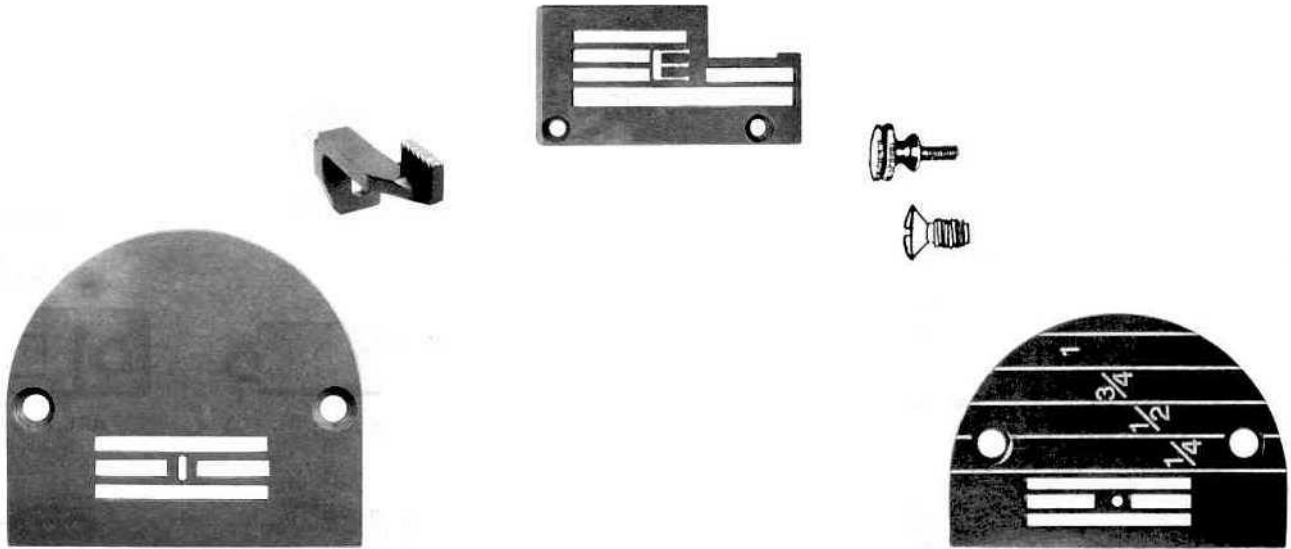

Unsere Erfahrung. Ihr Erfolg!

Großhandel für den Nähmaschinenfachhandel und die textilverarbeitende Industrie



Schrauben, Stichplatten und Transporteure

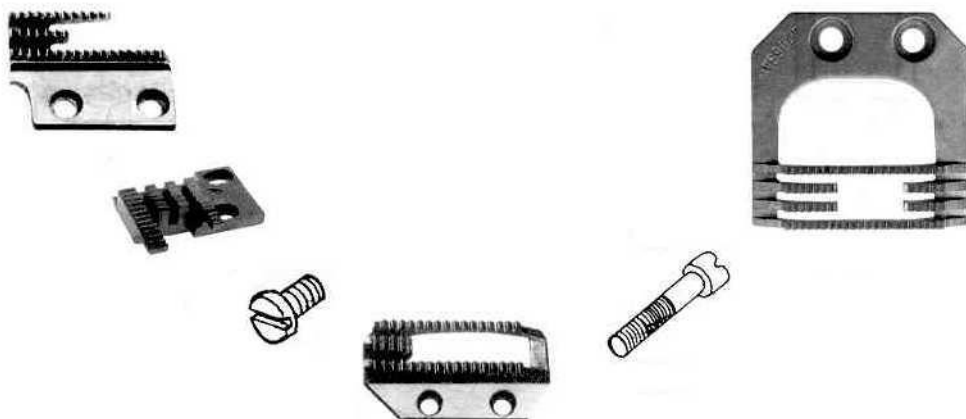

WDN GmbH
Basselweg 23
22527 Hamburg
Tel. +49 (0) 40 / 570 17 31-50
Fax: +49 (0) 40 / 570 17 31-70
E-mail: info@wdn.de - www.wdn.de

Geschäftsführer:
Dipl.-Ing. oec. Stefan Lange
Olaf Chrzanowski
AG Hamburg HRB 98234
Ust - Id Nr.: DE813412063
St. Nr.: 4576700305

Bankverbindung
Deutsche Bank AG
Konto:044477800 BLZ 200 700 24
SWIFT: DEUTDEDBHAM
IBAN: DE05 2007 0024 0044 4778 00

Inhaltsverzeichnis

Alle Teile sind keine Original - Ersatzteile

	Seite
Schrauben für Blindstichmaschinen (screws for blindstitch machines)	3
Schrauben für BROTHER (screws for BROTHER)	3
Schrauben für DÜRKOPP (screws for DÜRKOPP)	4
Schrauben für JUKI (screws for JUKI)	5
Schrauben für NECCHI (screws for NECCHI)	4
Schrauben für PEGASUS (screws for PEGASUS)	6
Schrauben für PFAFF (screws for PFAFF)	6
Schrauben für REECE (screws for REECE)	6
Schrauben für RIMOLDI (screws for RIMOLDI)	6
Schrauben für SINGER (screws for SINGER)	7
Schrauben für SIRUBA (screws for SIRUBA)	7
Schrauben für UNION SPECIAL (screws for UNION SPECIAL)	8
Schrauben für WILLCOX&GIBBS (screws for WILLCOX&GIBBS)	7
Schrauben für YAMATO (screws for YAMATO)	8
Stichplatten und Transporteure für ADLER (needle plates and feed dog for ADLER)	9
Stichplatten und Transporteure für BROTHER (needle plates and feed dog for BROTHER)	10 - 13
Stichplatten und Transporteure für DÜRKOPP (needle plates and feed dog for DÜRKOPP)	14 - 16
Stichplatten und Transporteure für JUKI (needle plates and feed dog for JUKI)	17 - 20
Stichplatten und Transporteure für KANSAI (needle plates and feed dog for KANSAI)	21 - 23
Stichplatten und Transporteure für NECCHI (needle plates and feed dog for NECCHI)	24 - 26
Stichplatten und Transporteure für PEGASUS (needle plates and feed dog for PEGASUS)	27 - 29
Stichplatten und Transporteure für PFAFF (needle plates and feed dog for PFAFF)	30 - 32
Stichplatten und Transporteure für RIMOLDI (needle plates and feed dog for RIMOLDI)	33 - 36
Stichplatten und Transporteure für SINGER (needle plates and feed dog for SINGER)	37 - 41
Stichplatten und Transporteure für SIRUBA (needle plates and feed dog for SIRUBA)	42 - 43
Stichplatten und Transporteure für UNION SPECIAL (needle plates and feed dog for UNION SPECIAL)	44 - 47
Stichplatten und Transporteure für YAMATO (needle plates and feed dog for YAMATO)	48 - 50
Umbausets für ADLER (transformation sets for ADLER)	9



Stichplatten und Transporteure



















Alle Teile, die mit dem Markenzeichen  gekennzeichnet sind, sind Ersatzteile von höchster Qualität eines deutschen Produzenten. Erfahrene Fachleute und modernste CNC-gesteuerte Produktionsmaschinen garantieren eine hohe Paßgenauigkeit und sorgfältigste Verarbeitung.



















Needle plates and feed dog

Every spare part, marked with the brand , are spare parts in highest quality produced from a German company. Experienced specialized workers and most modern CNC-controlled production machines guarantee highly accurate fitting and careful processing.







Schrauben für BROTHER (screws for BROTHER)

	ART. 7182 - # 009669-3-12		ART. 7136 - # 141514-0-01
	ART. 7183 - # 009670-6-12		ART. 7123 - # 143793-0-01
	ART. 7148 - # 009670-5-12		ART. 4986 - # 146427-0-01 Nadelschraube (needle screw)
	ART. 7228 - # 014680-4-22		ART. 5971 - # 152904-0-01
	ART. 5979 - # 018681-0-22		ART. 5962 - # 153208-0-01
	ART. 5963 - # 100032-0-01		ART. 5975 - # 153221-0-01
	ART. 5968 - # 111140-0-01		ART. 5972 - # 153222-0-01
	ART. 7100 - # 111140-0-02		ART. 7101 - # S00712-0-01
	ART. 7143 - # 115503-0-01		ART. 7102 - # S00722-0-01







Schrauben für Blindstich-Maschinen (screws for blindstitch machines)

	ART. 4886 - # 209-1 Messerbefestigung (knives fastening)		ART. 4882 - # 1108 (# 1108-6)
	ART. 4888 - # 1051		ART. 4837 - # 1114
	ART. 4889 - # 1071		ART. 4894 - # 1120
	ART. 4814 - # 1076S		ART. 4806 - # 1122S (# 1102)
	ART. 4891 - # 1097		ART. 4807 - # 1244-4 (# 1244)
	ART. 4881 - # 1098U (# 1099U)		ART. 4827 - # 1266 (# 1079) (# 1779)
	ART. 4819 - # 1101		ART. 4895 - # 1326
	ART. 4893 - # 1106		ART. 4896 - # 3050

Schrauben für DÜRKOPP (screws for DÜRKOPP)



















































































	ART. 1218 - # 211-387	Nadelschraube Kl. 211; 212; 271; 272 (needle screw cl. 211; 212; 271; 272)
	ART. 3240 - # 211-1129	Spannungsschraube für die Kapsel Kl. 211; 212; 271; 272 (bobbin case tension screw, cl. 211; 212; 271; 272)
	ART. 1226 - # 216-131	Kl. 211; 212; 216; 271; 272 (cl. 211; 212; 216; 271; 272)
	ART. 1224 - # 216-134	Stichplattenschraube, Kl. 211; 212; 216; 271; 272 (needle plate screw, cl. 211; 212; 216; 271; 272)
	ART. 1223 - # 216-406	Schraube für Fuß, Kl. 211; 212; 216 (presser foot screw, cl. 211; 212; 216)
	ART. 1225 - # 216-1157	Schraube für Kantenführungen (screw for guides)
	ART. 3241 - # 570-1252	Einstellschraube für Kapsel, Kl. 211; 212; 271; 272 (bobbin case adjustable screw, cl. 211; 212; 271; 272)

Schrauben für NECCHI (screws for NECCHI)

	ART. 378 - # 20307	Stichplattenschraube (needle plate screw)
	ART. 386 - # 52260	
	ART. 7010/1 - # 109197	
	ART. 379 - # 121387	Nadelschraube, Kl. 830; 831; 835 (needle screw, cl. 830; 831; 835)
	ART. 262 - # 137492	Schraube für Kantenführung (screw for guides)
	ART. 382 - # 746052	
	ART. 384 - # 746073	Schraube für Fuß (presser foot screw)

Schrauben für JUKI

(screws for JUKI)

	ART. 7541 - # B-1521-555-000		ART. 7563 - # SS-6661110-SP
	ART. 7539 - # SD-0460702-TP		ART. 7506 - # SS-7080510-TP
	ART. 7957 - # SD-0500091-TP		ART. 7950 - # SS-7090410-SP
	ART. 7547 - # SD-0630275-SP		ART. 7766 - # SS-7090510-SP
	ART. 7559 - # SD-0720332-SP		ART. 7624 - # SS-7090530-SP
	ART. 7947 - # SS-1060210-TP		ART. 7622 - # SS-7090540-SP
	ART. 7945 - # SS-1110640-TP		ART. 7550 - # SS-7090610-SP
	ART. 7543 - # SS-2060210-SP		ART. 9717 - # SS-7090611-SL
	ART. 7936 - # SS-2060510-SP		ART. 7704 - # SS-7090850-SP
	ART. 9704 - # SS-2090520-SL		ART. 7522 - # SS-7091110-SP
	ART. 7693 - # SS-2110710-TP		ART. 7564 - # SS-7110510-SP
	ART. 9912 - # SS-2110910-SL		ART. 7565 - # SS-7110740-TP
	ART. 7495 - # SS-2110915-SP		ART. 7566 - # SS-7110840-SP
	ART. 7494 - # SS-2110920-TP		ART. 9756 - # SS-7110910-TP
	ART. 9707 - # SS-3090610-SP		ART. 7567 - # SS-7111120-SP
	ART. 7780 - # SS-4030310-SP		ART. 7726 - # SS-7111410-SP
	ART. 7656 - # SS-4080610-SP		ART. 7566 - # SS-7111840-SP
	ART. 7491 - # SS-4080620-TP		ART. 7568 - # SS-7121410-SP
	ART. 7697 - # SS-4090615-SP		ART. 7721 - # SS-7161040-SP
	ART. 9734 - # SS-4110515-SP		ART. 7569 - # SS-7681650-TP
	ART. 7560 - # SS-4111015-SP		ART. 7644 - # SS-8080310-TP
	ART. 7544 - # SS-4110715-SP		ART. 4199 - # SS-8080310-TP sechskant (hexagonal)
	ART. 7484 - # SS-4120915-SP		ART. 7632 - # SS-8090410-SP
	ART. 7629 - # SS-5060310-SP		ART. 7469 - # SS-8090670-SP
	ART. 7730 - # SS-5060410-SP		ART. 7570 - # SS-8110410-TP
	ART. 9713 - # SS-5110710-SP		ART. 7600 - # SS-8110422-TP
	ART. 7490 - # SS-6060210-SP		ART. 7468 - # SS-8110710-SP
	ART. 9778 - # SS-6060440-TP		ART. 7571 - # SS-8151150-SP
	ART. 7909 - # SS-6080340-SP		ART. 7462/1 - # SS-8151570-SP
	ART. 7478 - # SS-6080410-SP		ART. 7572 - # SS-8660610-TP
	ART. 9743 - # SS-6080720-SP		ART. 7509 - # SS-8660810-TP
	ART. 7546 - # SS-6090510-SP		ART. 7573 - # SS-8681650-TP
	ART. 9779 - # SS-6090620-TP		ART. 7712 - # SS-9090610-TP
	ART. 7561 - # SS-6090620-SP		ART. 7773 - # SS-9090813-TP
	ART. 7694 - # SS-6090650-SP		ART. 9764 - # SS-9110430-TP
	ART. 7505 - # SS-6090670-TP		ART. 7654 - # SS-9111010-SP
	ART. 7955 - # SS-6110430-TP		ART. 7655 - # SS-9111050-SP
	ART. 7486 - # SS-6110610-TP		ART. 7776 - # SS-9111610-SP
	ART. 7518 - # SS-6111010-SP		ART. 7778 - # SS-9112310-SP
	ART. 7771 - # SS-6111040-SP		ART. 7645 - # SS-9151210-TP
	ART. 9909 - # SS-6111610-SP		ART. 7574 - # SS-9151540-SR
	ART. 7562 - # SS-6120930-TP		

Schrauben für PEGASUS (screws for PEGASUS)



ART. 6310 - # 2921

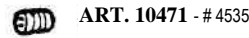

ART. 10471 - # 4535

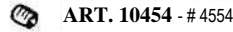

ART. 10454 - # 4554

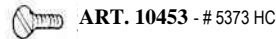

ART. 10453 - # 5373 HC

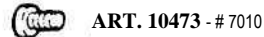

ART. 10473 - # 7010

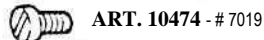

ART. 10474 - # 7019

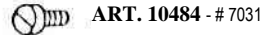

ART. 10484 - # 7031

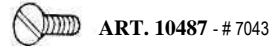

ART. 10487 - # 7043

Schrauben für PFAFF (screws for PFAFF)

ART. 1960 - # 11-174086-15 (700288)
Nadelschraube, Kl. 145; 146; 335 (needle screw, cl. 145; 146; 335)ART. 1949 - # 11-330085-15 (330085)
Nadelschraube, Kl. 481; 483 (needle screw, cl. 481; 483)ART. 1946 - # 91-100073-35
Kl. 145; 146; 335 (cl. 145; 146; 335)

ART. 2125 - # 91-000219-15 (219P)

ART. 383 - # 91-000407-15 (407-15)
Klasse 145; 146; 242; 463; 483 (cl. 145; 146; 242; 463; 483)ART. 1945 - # 91-000407-15 (407-15), Stichplattenschraube,
Kl. 145; 146; 242 (needle plate screw, cl. 145; 146; 335)ART. 377 - # 91-000422-35 (422)
Stichplattenschraube, Kl. 463 (needle plate screw, cl. 463)

ART. 1995 - # 91-000509-15 (509)



ART. 1985 - # 91-000785-05 (785)

ART. 1948 - # 91-100296-35 (296-35)
Stichplattenschraube, Kl. 481; 483 (needle plate screw, cl. 481; 483)ART. 261 - # 91-700112-25 (700112)
Befestigung für Kantenführungen (screws for guides)ART. 1905 - # 91-700868-15 (700868)
Nadelschraube, Kl. 138; 238; 438 (needle screw, cl. 138; 238; 438)

ART. 2080 - # 91-700991-15 (700991)



ART. 2085 - # 91-701344-35 (701344)

Schrauben für REECE (screws for REECE)



ART. 2196 - # 01-1069 (1069)



ART. 2197 - # 01-2019 (2019)



ART. 2198 - # 01-2131 (2131)



ART. 2288 - # 01-2193 (2193) Nadelschraube S2 (needle screw S2)



ART. 2194 - # 01-2313 (2313)



ART. 2199 - # 01-2351 (2351)



ART. 2355 - # 01-2385 (2385)



ART. 2193 - # 01-2386 (2386)

ART. 2192 - # 10-3038-1-000
Einstellschraube (adjustable screw)

Schrauben für RIMOLDI (screws for RIMOLDI)



ART. 2788 - # 202488-0-10



ART. 2789 - # 202489-0-10

ART. 2786 - # 202496-0-10 Obermesserschraube
(upper knife screw)

ART. 2777 - # 204947-0-10

ART. 2763 - # 740236-0-00
Befestigung für Kantenführungen (screws for guides)

ART. 2780 - # 741413-0-00

ART. 2784 - # 741433-0-00
Kettentrennerschraube (chain cutter screw)ART. 2785 - # 744742-0-00
Stichplattenschraube (needle plate screw)

ART. 2764 - # 745800-2-00 Nadelschraube (needle screw)



ART. 2787 - # 745812-2-00

Schrauben für SINGER (screws for SINGER)

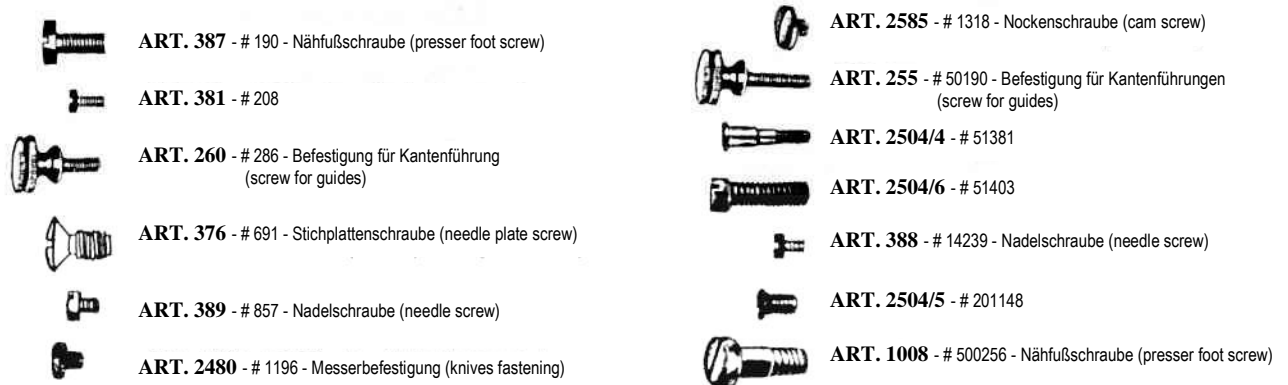



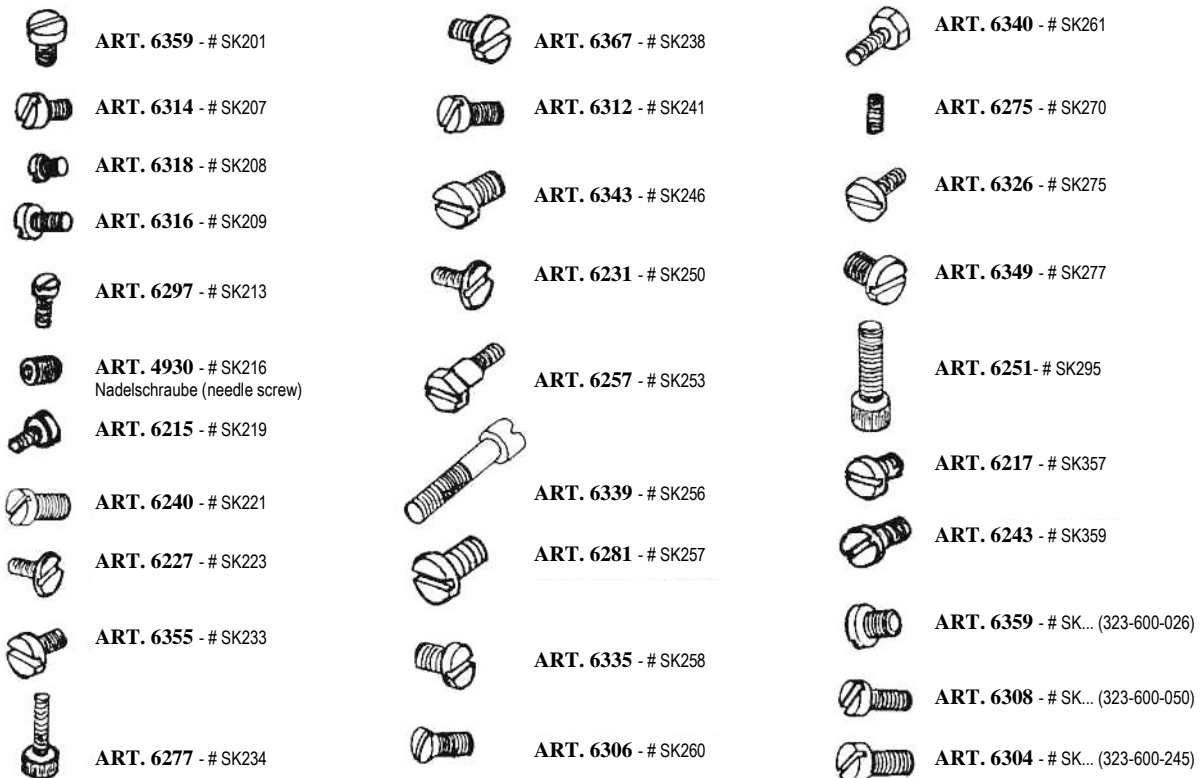



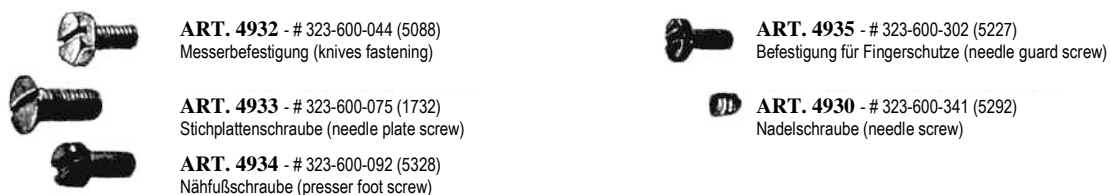



























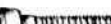



































Schrauben für SIRUBA (screws for SIRUBA)



Schrauben für WILLCOX & GIBBS (PEGASUS) (screws for WILLCOX & GIBBS - PEGASUS -)





Schrauben für UNION SPECIAL (screws for UNION SPECIAL)

ART. 6932 - # 22KH		ART. 6957 - # 91		ART. 6995 - # 22569B	
ART. 6933 - # 28		ART. 6958 - # 93		ART. 6977 - # 22574	
ART. 6934 - # 28B		ART. 6959 - # 93A		ART. 6978 - # 22588A	
ART. 6935 - # 28C		ART. 6960 - # 94		ART. 6979 - # 22588J	
ART. 6936 - # 57WD		ART. 6961 - # 95		ART. 6751 - # 22652A-6	
ART. 6937 - # 73		ART. 6962 - # 97X		ART. 2918 - # 22704	
ART. 6938 - # 73A		ART. 6963 - # 98		ART. 6980 - # 22716	
ART. 6939 - # 73X		ART. 6964 - # 187A		ART. 6981 - # 22716A	
ART. 6940 - # 74		ART. 6965 - # 376		ART. 2898 - # 22738B	
ART. 6941 - # 74A		ART. 6797 - # 376A		ART. 6982 - # 22738C	
ART. 6942 - # 74E		ART. 6966 - # 420		ART. 6983 - # 22738H	
ART. 6943 - # 75		ART. 6715 - # 605		ART. 6984 - # 22768	
ART. 6944 - # 75A		ART. 6967 - # 605A		ART. 2905 - # 22768B	
ART. 6945 - # 77S		ART. 6968 - # 1096B		ART. 6985 - # 22840A	
ART. 6946 - # 80		ART. 6922 - # 22513		ART. 6986 - # 22845A	
ART. 6947 - # 81		ART. 6969 - # 22524		ART. 6987 - # 22892B	
ART. 6948 - # 87		ART. 6970 - # 22525		ART. 6988 - # 22894C	
ART. 6949 - # 87A		ART. 6971 - # 22526		ART. 6989 - # 22894P	
ART. 6950 - # 87U		ART. 6972 - # 22528		ART. 6990 - # BP108	
ART. 6951 - # 88		ART. 6712 - # 22562A		ART. 6991 - # J87J	
ART. 6952 - # 88A		ART. 6973 - # 22564			
ART. 6953 - # 88B		ART. 6713 - # 22564D			
ART. 6954 - # 88D		ART. 6974 - # 22564E			
ART. 6955 - # 89		ART. 6975 - # 22564F			
ART. 6956 - # 90		ART. 6976 - # 22564G			



Schrauben für YAMATO (screws for YAMATO)

 ART. 4199 - # 3637
Nadelschraube (needle screw)

 ART. 4201 - # 3638
Greiferschraube (looper screw)

 ART. 4203 - # 4404
Kettentrennerschraube (chain cutter screw)

 ART. 4202 - # 5401
Stichplattenschraube (needle plate screw)

Stichplatten und Transporteure für ADLER (needle plates and feed dog for ADLER)

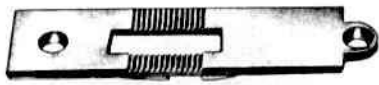

ART. 1125 - # 067-20-036-0
Kl. 67 (cl. 67)

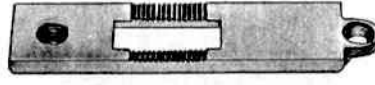

ART. 1130 - # 167-20-007-0
Kl. 167 (cl. 167)



ART. 1139 - # 467-20-009-0
Kl. 467 (cl. 467)



ART. 1135
067-21-028-0



ART. 1140
167-21-010-0



ART. 1141
467-21-006-0



ART. 1131 - # 067-20-039-0
Kl. 67; 167; 267 (cl. 67; 167; 267)



ART. 1133 - # 367-20-022-0
Kl. 367; 467; 767 (cl. 367; 467; 767)



ART. 1143 - # 069-00-133-0
Kl. 69 (cl. 69)



ART. 1132
067-21-030-0



ART. 1134
367-21-016-0



ART. 1142
069-00-268

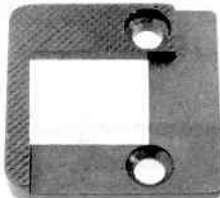

ART. 1144 - # 069-20-100
Kl. 69 (cl. 69)



ART. 1146/1 - # 069-20-015-0
Kl. 69 (cl. 69)



ART. 1145
069-21-100



ART. 1147/1
069-21-014-0

Umbauset für ADLER Kl. 69
(transformation set for ADLER cl. 69)

ART. 5785
069-00-391-0

ART. 5786
069-22-117-3

ART. 1145
069-21-100

Umbauset für ADLER Kl. 367; 467; 767
(transformation set for ADLER cl. 367; 467; 767)

ART. 5797
367-22-050-3

ART. 5798
067-22-080-3

ART. 1134
367-21-016-0

Umbauset für ADLER Kl. 67; 167; 267
(transformation set for ADLER cl. 67; 167; 267)

ART. 5785
069-00-391-0

ART. 5786
069-22-117-3

ART. 1131 - # 067-20-039-0

Stichplatten und Transporteure für BROTHER (needle plates and feed dog for BROTHER)

Kl. 705; 707; 716; 737; 755; 757; 763; etc. (cl. 705; 707; 716; 737; 755; 757; 763; etc.)

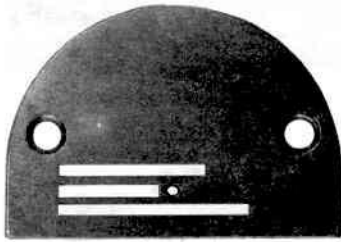

ART. 6047 - # 100266-0-01 (∅ 1,8 mm)

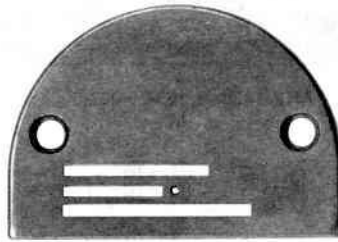

ART. 6053 - # 146050-0-01 (∅ 1,4 mm)

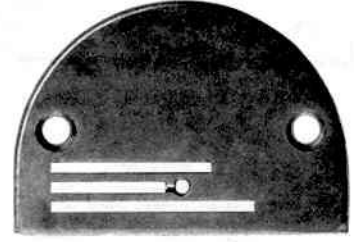

ART. 6051 - # 111508-0-01 (∅ 2,6 mm)

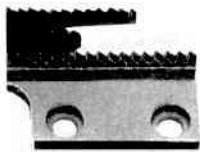

ART. 6048 - # 100334-0-01

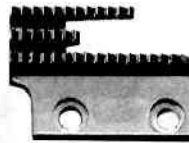

ART. 6052 - # S02742-0-01

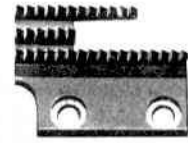

ART. 6044 - # 147493-0-01

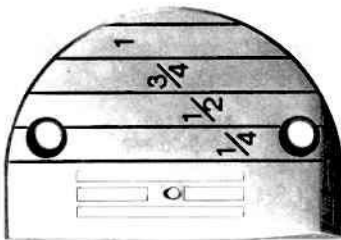

ART. 6045 - # S00867-0-01

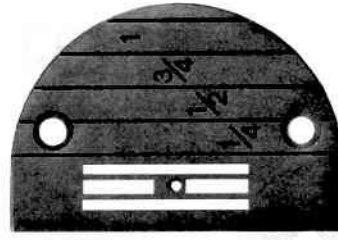

ART. 6037 - # 111859-0-01 (∅ 1,8 mm)

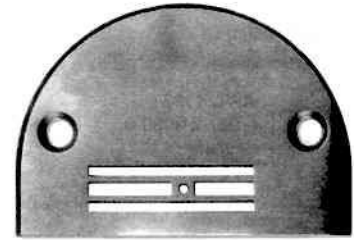

ART. 6043 - # 156116-0-01 (∅ 1,8 mm)



ART. 6046 - # S00868-0-01

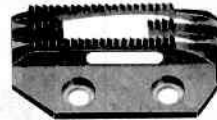

ART. 6038 - # 111860-0-01

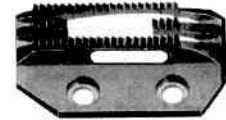

ART. 6038 - # 111860-0-01



ART. 6035 - # 100603-0-01 (∅ 1,4 mm)

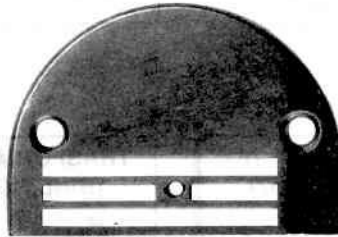

ART. 6041 - # 150792-0-01 (∅ 2,6 mm)

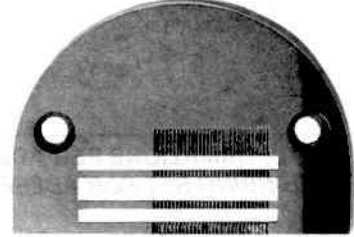

ART. 6055 - # S01988-0-01



ART. 6036 - # 111898-0-01

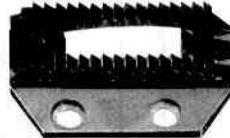

ART. 6042 - # 150793-0-01

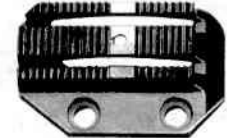

ART. 6056 - # S01989-0-01







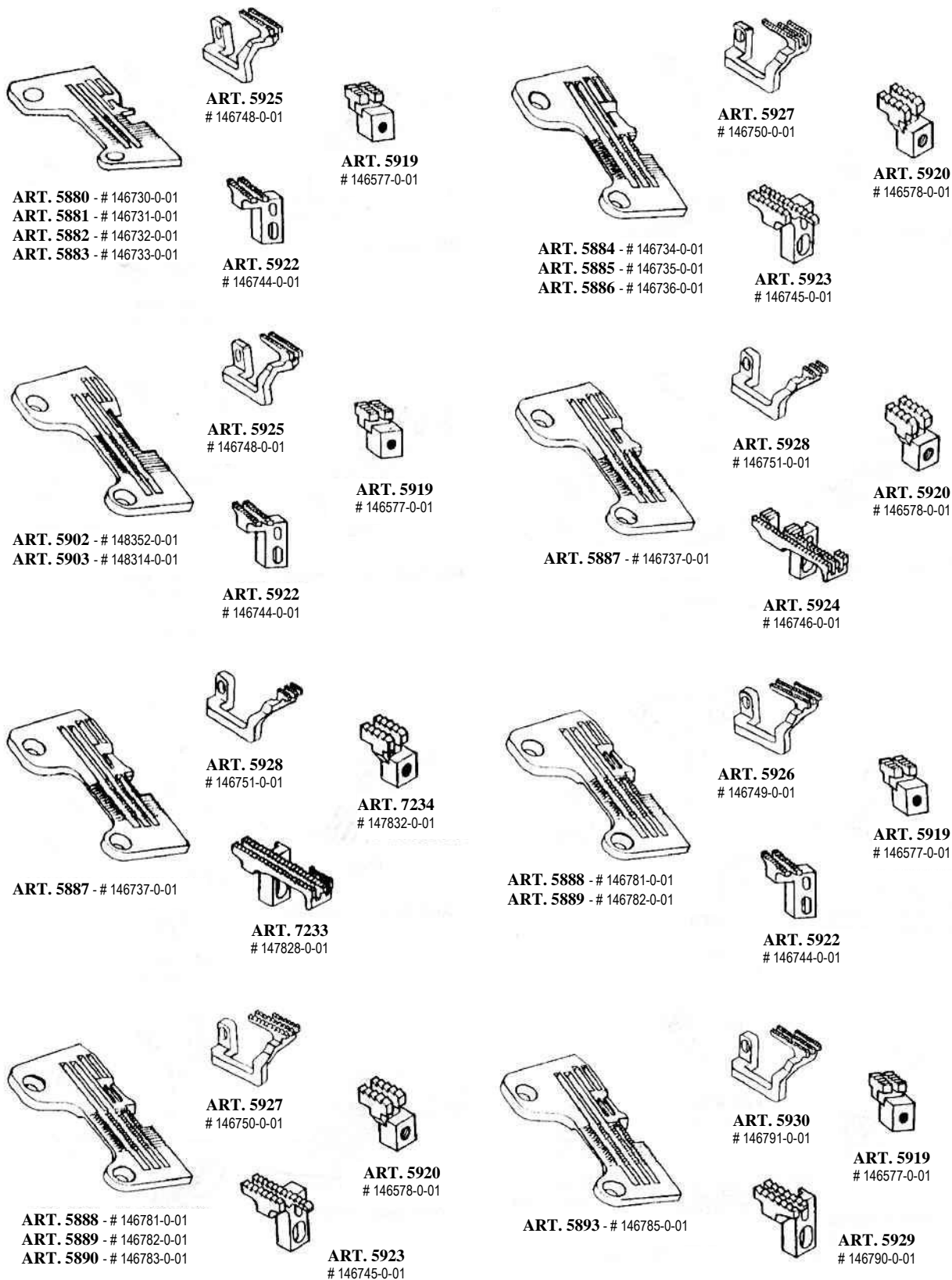



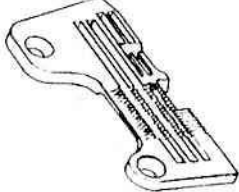
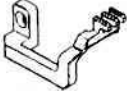

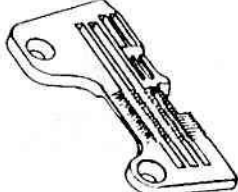
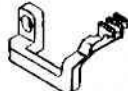



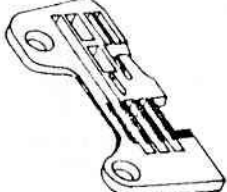
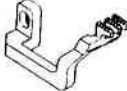

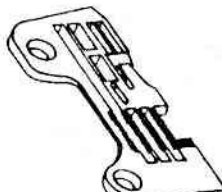
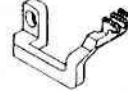

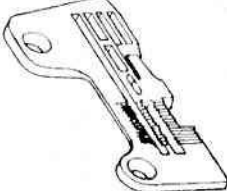
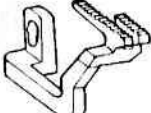
Stichplatten und Transporteure für BROTHER

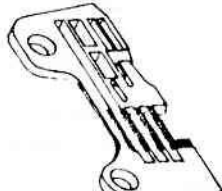
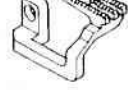
(needle plates and feed dog for BROTHER)

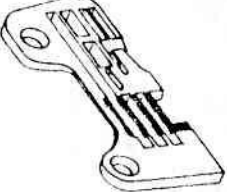
Kl. EF4-B511, 531, 551, 561 (cl. EF4-B511, 531, 551, 561)

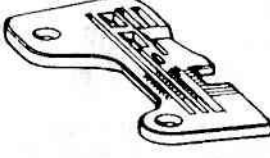

Stichplatten und Transporteure für BROTHER (needle plates and feed dog for BROTHER) Kl. EF4-B511, 531, 551, 561 (cl. EF4-B511, 531, 551, 561)

	 ART. 5928 # 146751-0-01  ART. 5920 # 146578-0-01		 ART. 5928 # 146751-0-01  ART. 7234 # 147832-0-01
ART. 5892 - # 146786-0-01	 ART. 5924 # 146746-0-01	ART. 5892 - # 146786-0-01	 ART. 7233 # 147828-0-01
	 ART. 5918 # 146576-0-01  ART. 5920 # 146578-0-01		 ART. 5917 # 146575-0-01  ART. 5920 # 146578-0-01
ART. 5899 - # 146509-0-01	ART. 5913 # 146571-0-01	ART. 5898 - # 146508-0-01	ART. 5912 # 146570-0-01
	 ART. 5914 # 146572-0-01  ART. 5919 # 146577-0-01		 ART. 5915 # 146573-0-01  ART. 5919 # 146577-0-01
ART. 7243 - # 146498-0-01 ART. 5894 - # 146501-0-01 ART. 5896 - # 146503-0-01	 ART. 5921 # 146567-0-01	ART. 5897 - # 146504-0-01	ART. 5910 # 146568-0-01
	 ART. 5916 # 146574-0-01  ART. 5919 # 146577-0-01		 ART. 5917 # 146575-0-01  ART. 5920 # 146578-0-01
ART. 5900 - # 146510-0-01 ART. 7248 - # 159769-0-01 ART. 5904 - # 159770-0-01	 ART. 5911 # 146569-0-01	ART. 5908 - # S01773-0-01	ART. 7257 # S01777-0-01

Stichplatten und Transporteure für BROTHER (needle plates and feed dog for BROTHER)

Kl. MA4-B661, 061, 063, 065, etc. (cl. MA4-B661, 061, 063, 065, etc.)

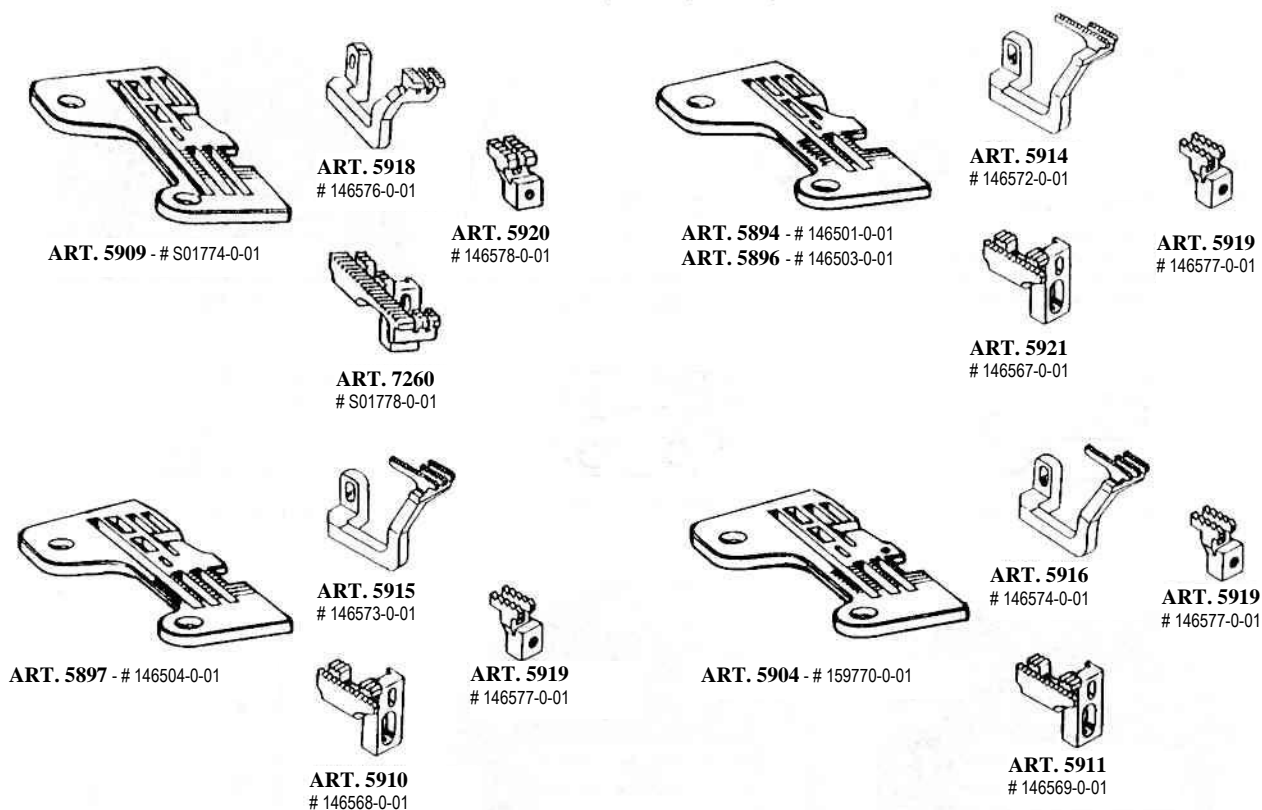

Weitere BROTHER Stichplatten (ohne Abbildung)
(more BROTHER needle plates, not shown)

ART. 5891 - # 146784-0-01
ART. 5901 - # 146498-0-01
ART. 5906 - # S01711-0-01

ART. 5907 - # S01713-0-01
ART. 5895 - # 146502-0-01
ART. 5905 - # 156331-0-01

Kl. LT2-B832; 835 Fadenabschneider (cl. LT2-B832; 835 thread trimmer)

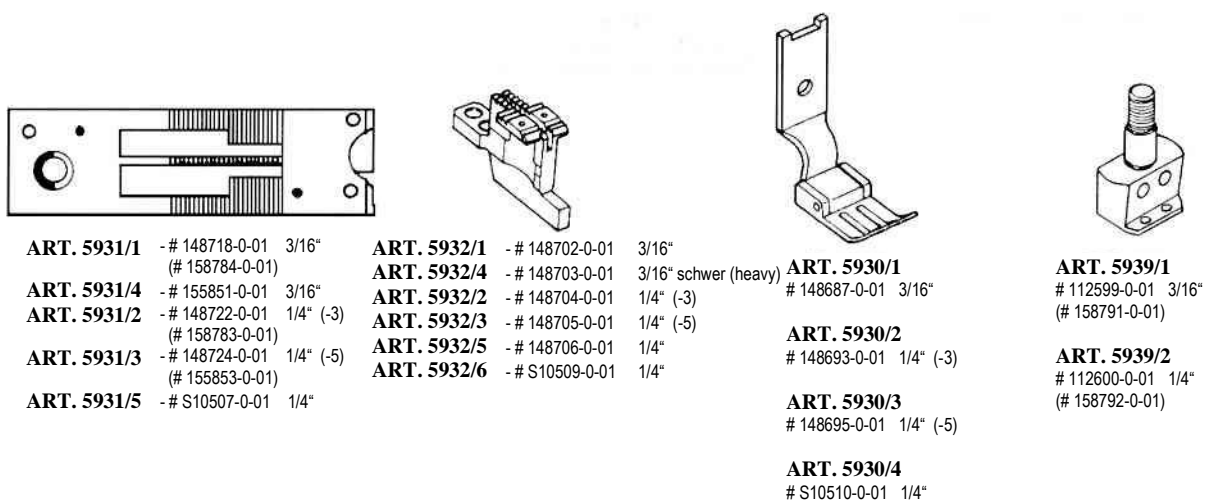

Stichplatten und Transporteure für DÜRKOPP (needle plates and feed dog for DÜRKOPP) Kl. 211; 212 (cl. 211; 212)

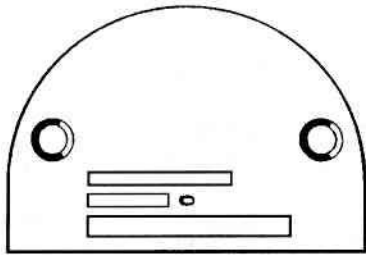

ART. 785 - # 204243

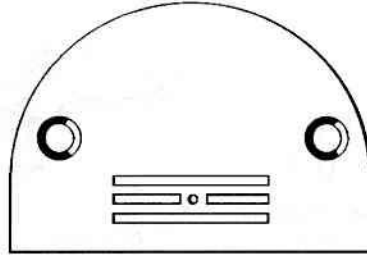

ART. 790 - # 204235

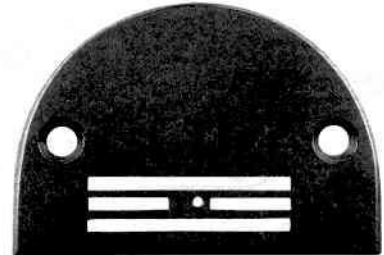

ART. 795 - # 2114521

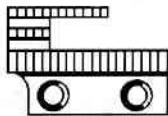

ART. 800 - # 204268

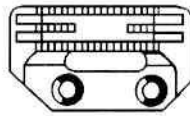

ART. 805 - # 204260

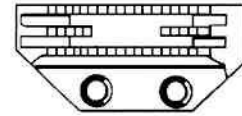

ART. 810 - # 2114522

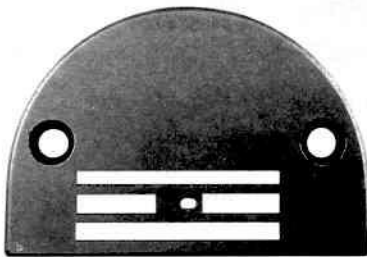

ART. 647 - # 2111491
schwer (heavy)

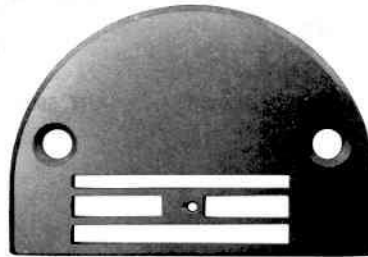

ART. 646
mittelschwer (medium-heavy)



ART. 660 - # 271-006603
schwer (heavy)

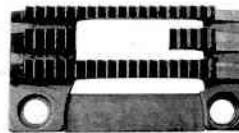

ART. 644
Fadenabschneider, mittelschwer
(thread trimmer, medium heavy)



Kl. 555
(cl. 555)

ART. 870
555815

Stichplatten und Transporteure für DÜRKOPP (needle plates and feed dog for DÜRKOPP)

Kl. 211; 212 (cl. 211; 212)

ART. 1318/1

211-9823

Fadenabschneider (thread trimmer)

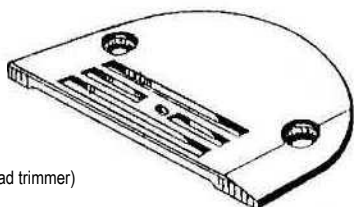

ART. 1314/1

211-9795

Fadenabschneider (thread trimmer)

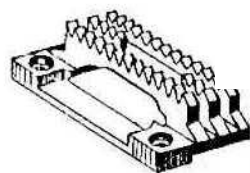
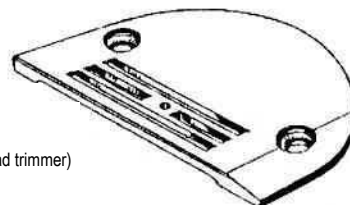

ART. 1319/1

211-9824

Fadenabschneider (thread trimmer)

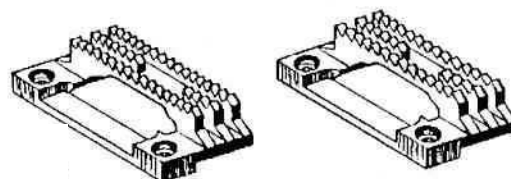

ART. 1316/1

211-50511 (# 211-9794)

Fadenabschneider (thread trimmer)

ART. 1317/1

211-50505 (# 211-9796)

Fadenabschneider (thread trimmer)

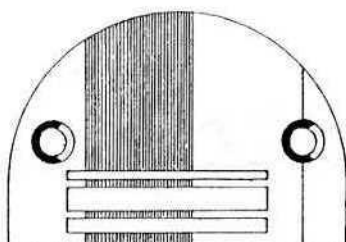

ART. 6500/1

212-83284 (# 212V40046)

Fadenabschneider (thread trimmer)

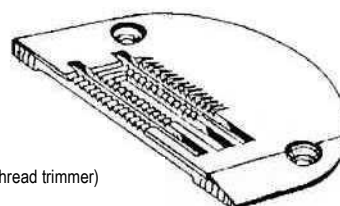

ART. 1306/1

212-10998

Fadenabschneider (thread trimmer)

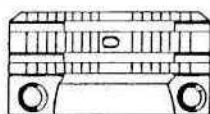

ART. 6501/1

212-83288 (# 212V40048)

Fadenabschneider (thread trimmer)

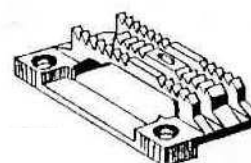

ART. 1307/1

212-52102

Fadenabschneider (thread trimmer)

Kl. 271; 272 (cl. 271; 272)

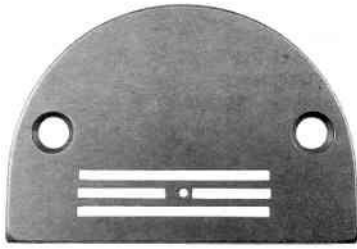

ART. 6594 - # 271-006504
leicht (light)



ART. 6596 - # 271-006601
leicht (light)

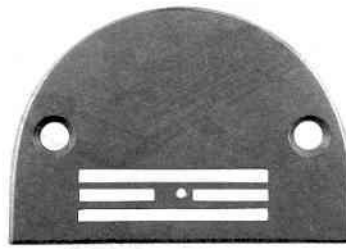

ART. 795 - # 211-004521
mittel (medium)



ART. 6598 - # 271-006602
mittel (medium)

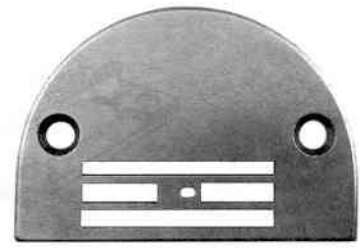

ART. 647 - # 211-001491
schwer (heavy)



ART. 6600 - # 271-006603
schwer (heavy)

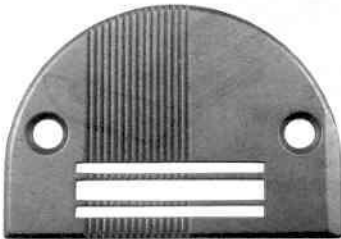

ART. 6602 - # 272-006501
leicht (light)



ART. 6604 - # 272-006601
leicht (light)

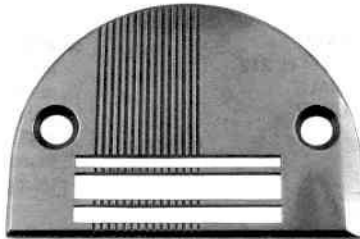

ART. 6606 - # 272-006502
mittel (medium)



ART. 6608 - # 272-006602
mittel (medium)

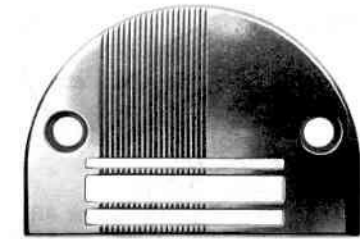

ART. 6610 - # 272-006503
schwer (heavy)



ART. 6612 - # 272-006603
schwer (heavy)

Stichplatten und Transporteure für JUKI (needle plates and feed dog for JUKI)

Kl. DDL-555; 5550 (cl. DDL-555; 5550)

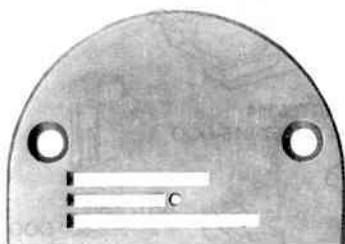

ART. 7609 - # B-1109-012-A00

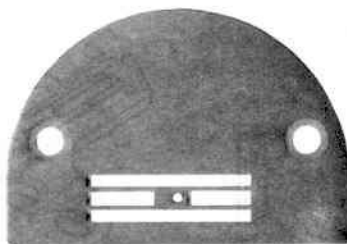

ART. 7576 - # B-1109-012-I00

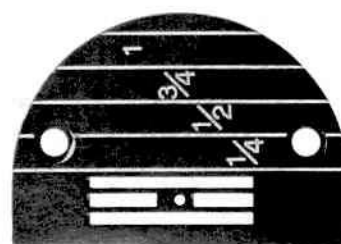

ART. 7496 - # B-1109-552-000

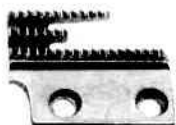

ART. 7577 - # B-1613-012-A00

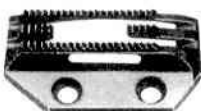

ART. 7534 - # B-1613-012-I00

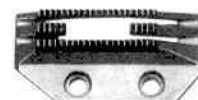

ART. 7493 - # B-1613-552-000

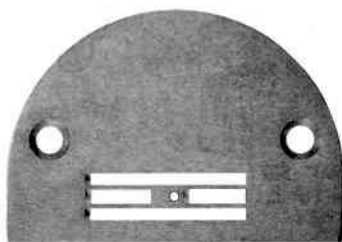

ART. 7533 - # D-1109-555-D01
(# B-1109-012-I0B)

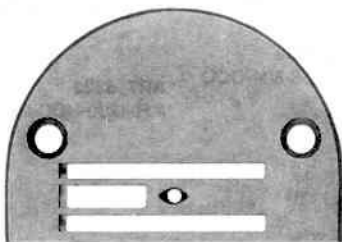

ART. 7529 - # B-1109-555-H0B

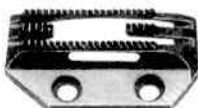

ART. 7534 - # B-1613-012-I00



ART. 7530 - # B-1613-555-H00

Kl. MO-804; 812; 814; 816 (cl. MO-804; 812; 814; 816)

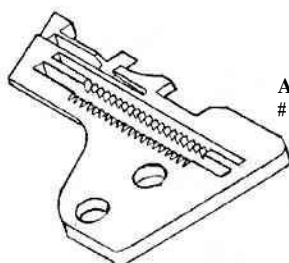

ART. 5320
R4200-EOD-C00

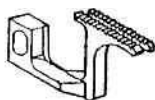

ART. 5358
B-1657-805-000A



ART. 5369
B-1658-804-000



ART. 5347
B-1656-805-000

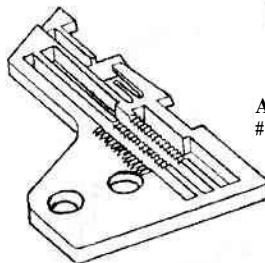

ART. 5333 - # B-4308-EOD-E00
ART. 5334 - # B-4308-E0F-E00

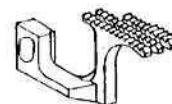

ART. 5359
B-1657-812-DOA



ART. 5370
B-1658-812-00A



ART. 5348
B-1656-812-DOC

Stichplatten und Transporteure für JUKI (needle plates and feed dog for JUKI) Kl. MO-804; 812; 814; 816 (cl. MO-804; 812; 814; 816)

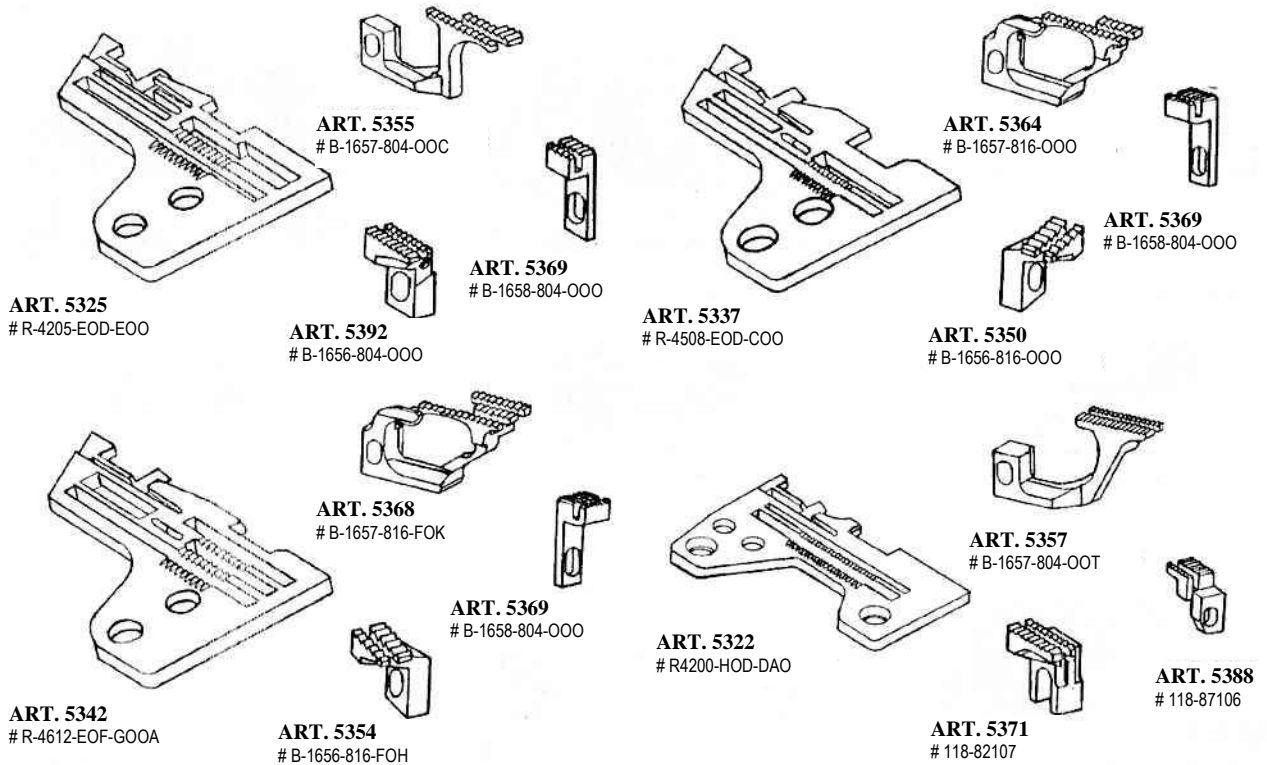

Kl. MO-2504; 2512; 2516; 2543 (cl. MO-2504; 2512; 2516; 2543)

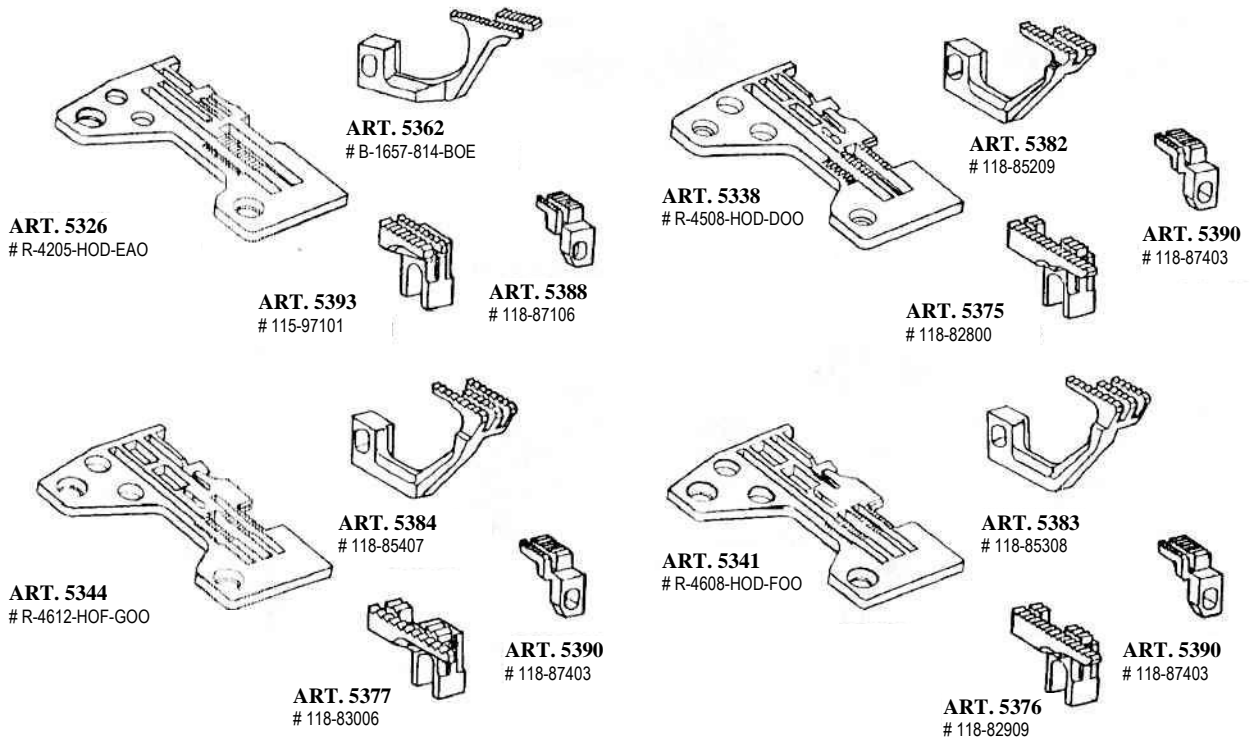

Stichplatten und Transporteure für JUKI (needle plates and feed dog for JUKI)

Kl. MO-2504; 2512; 2516; 2543 (cl. MO-2504; 2512; 2516; 2543)

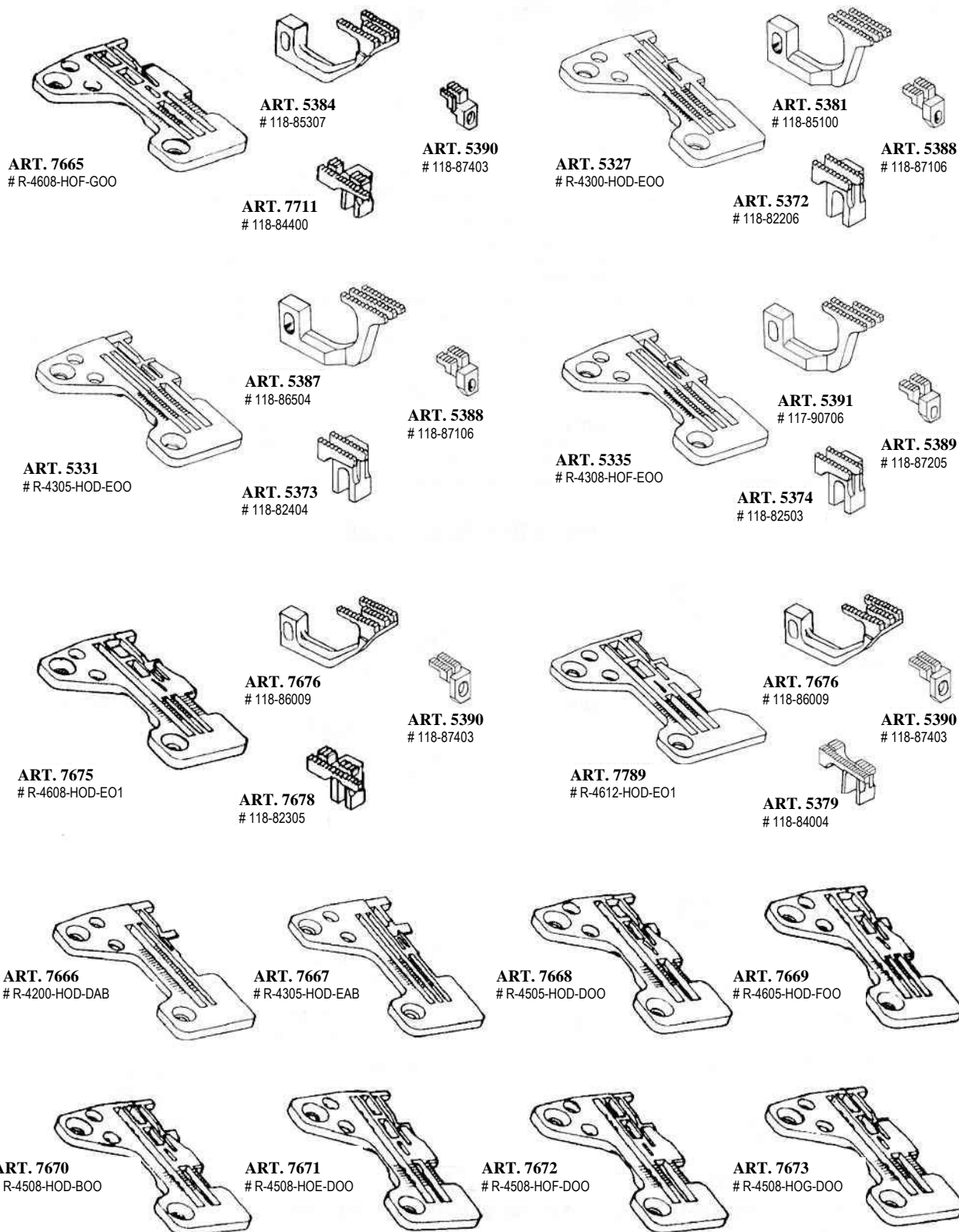

Stichplatten und Transporteure für JUKI (needle plates and feed dog for JUKI)

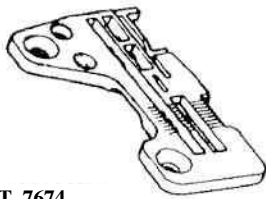

ART. 7674
R-4508-HOH-DOO

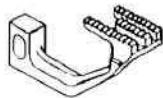

ART. 7676
118-86009



ART. 7677
118-82602



ART. 7679
118-87304

**Kl. MO-2504; 2512;
2516; 2543**
(cl. MO-2504; 2512;
2516; 2543)

Weitere JUKI Stichplatten, ohne Abbildung (more JUKI needle plates, not shown)

ART. 5330 - # R-4300-H2D-EOO
ART. 5340 - # R-4608-EOF-GOO
ART. 5323 - # R-4200-H2D-DOO
ART. 5328 - # R-4300-HOD-DAO

ART. 5336 - # R-4308-EOF-EOA
ART. 5343 - # R-4612-HOF-BOO
ART. 5324 - # R-4200-H2D-DOF
ART. 5329 - # R-4300-HOD-EOO

ART. 5332 - # R-4305-HOD-EOA
ART. 5339 - # R-4608-EOD-FOO
ART. 5321 - # R-4200-HOD-DOO

Weitere JUKI Transporteure, ohne Abbildung (more JUKI feed dog, not shown)

ART. 5345 - # B-1656-804-OOL
ART. 5351 - # R-1656-816-DOG
ART. 5356 - # R-1657-9804-OOP
ART. 5363 - # R-1657-814-BOL
ART. 5367 - # R-1657-816-FOFA
ART. 5380 - # 118-84103

ART. 5386 - # 118-85902
ART. 5346 - # B-1656-812-DOE
ART. 5352 - # B-1656-816-DOJ
ART. 5360 - # B-1657-812-DOB
ART. 5365 - # B-1657-816-DOG
ART. 5378 - # 118-83907

ART. 5349 - # B-1656-814-BOB
ART. 5353 - # B-1656-816-FODA
ART. 5361 - # B-1657-814-BOC
ART. 5366 - # B-1657-816-DOJ
ART. 5385 - # 118-85803

Kl. MO-3604; 3614; 3616 (cl. MO-3604; 3614; 3616)

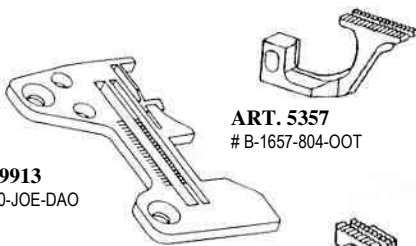

ART. 9913
R-4200-JOE-DAO

ART. 5357
B-1657-804-OOT



ART. 5388
118-87106

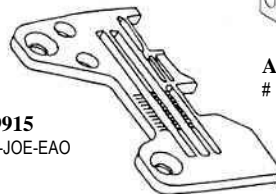

ART. 9915
R-4305-JOE-EAO

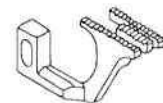

ART. 9761
119-49906



ART. 5388
118-87106



ART. 5371
118-82107



ART. 9759
119-49807

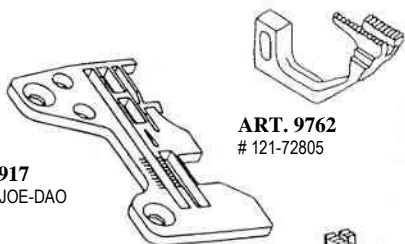

ART. 9917
R-4508-JOE-DAO

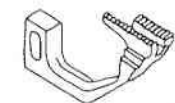

ART. 9762
121-72805



ART. 5390
118-87403

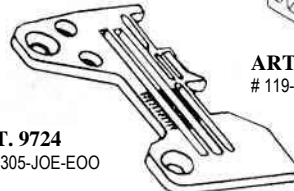

ART. 9724
R-4305-JOE-EOO

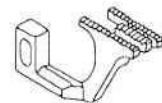

ART. 9761
119-49906



ART. 5388
118-87106



ART. 5375
118-82800



ART. 9759
119-49807

Stichplatten und Transporteure für KANSAI (needle plates and feed dog for KANSAI)

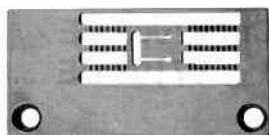

ART. 9026/1 - # 14-744 (3/16")
ART. 9026/2 - # 14-754 (7/32")
ART. 9026/3 - # 14-764 (1/4")



ART. 9027
15-723



ART. 9028
15-753

**Kl. (cl.) W8002 D,
W8102 D**



ART. 9031/1 - # 14-854 (7/32")
ART. 9031/2 - # 14-764 (1/4")



ART. 9027
15-723



ART. 9028
15-753

**Kl. (cl.) W8003 D,
W8103 D**

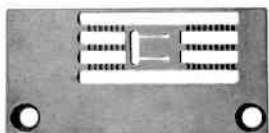

ART. 9026/1 - # 14-744 (3/16")
ART. 9026/2 - # 14-754 (7/32")
ART. 9026/3 - # 14-764 (1/4")



ART. 9027
15-723



ART. 9028
15-753

**Kl. (cl.) 2202 D,
V7102 D**

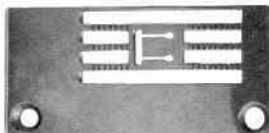

ART. 9034/1 - # 14-745 (3/16")
ART. 9034/2 - # 14-755 (7/32")
ART. 9034/3 - # 14-765 (1/4")



ART. 9027
15-723



ART. 9028
15-753

**Kl. (cl.) W8002 DE;
W8102 DE**

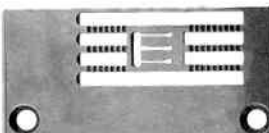

ART. 9036/1 - # 14-855 (7/32")
ART. 9036/2 - # 14-865 (1/4")



ART. 9027
15-723



ART. 9028
15-753

**Kl. (cl.) W8003 DE,
W8103 DE**

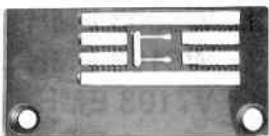

ART. 9034/1 - # 14-745 (3/16")
ART. 9034/2 - # 14-755 (7/32")
ART. 9034/3 - # 14-765 (1/4")



ART. 9027
15-723



ART. 9028
15-753

**Kl. (cl.) V7002,
V7102 DE**

Stichplatten und Transporteure für KANSAI (needle plates and feed dog for KANSAI)

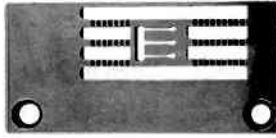

ART. 9036/1 - # 14-855 (7/32")
ART. 9036/2 - # 14-565 (1/4")



ART. 9027
15-723



ART. 9028
15-753

**Kl. (cl.) V7003 DE,
V7103 DE**

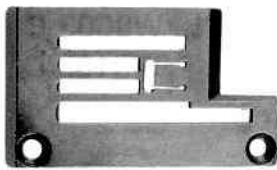

ART. 9040/1 - # 14-746 (3/16")
ART. 9040/2 - # 14-756 (7/32")
ART. 9040/3 - # 14-766 (1/4")



ART. 9041
15-727



ART. 9042
15-756

**Kl. (cl.) W8002 D,
W8102 D,
V7102**



ART. 9044 - # 14-866 (1/4")



ART. 9041
15-727



ART. 9042
15-756

**Kl. (cl.) W8003 F,
W8103 F,
V7103**

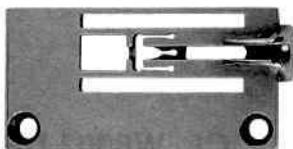

ART. 9046 - # 14-8020 (1/4")



ART. 9047
15-7610



ART. 9048
15-7310

**Kl. (cl.) W8003 C,
W8103 C**

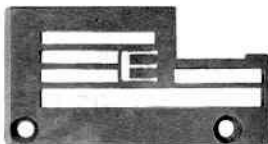

ART. 9050 - # 14-868 (1/4")



ART. 9051
15-728



ART. 9052
15-828

**Kl. (cl.) W8003 EMH,
W8103 EMH,
V7103 EMH**

Stichplatten und Transporteure für KANSAI (needle plates and feed dog for KANSAI)

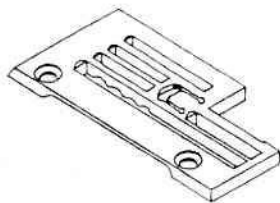

ART. 9086/1 - # 14-748 (3/16")
ART. 9086/2 - # 14-758 (7/32")
ART. 9086/3 - # 14-768 (1/4")

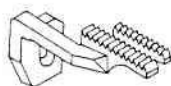

ART. 9051
15-728



ART. 9052
15-828

**Kl. (cl.) W8002 EMK,
W8102 EMK**

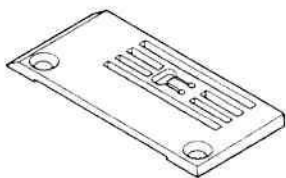

ART. 9094/1 - # 14-806 (1/8")
ART. 9094/2 - # 14-807 (5/32")
ART. 9094/3 - # 14-808 (3/16")
ART. 9094/4 - # 14-809 (7/32")
ART. 9094/5 - # 14-810 (1/4")

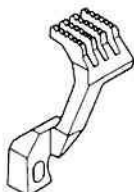

ART. 9095 - # 15-805
ART. 9095 - # 15-805
ART. 9095 - # 15-805
ART. 9096 - # 15-807
ART. 9096 - # 15-807



ART. 9098 - # 15-806
ART. 9098 - # 15-806
ART. 9098 - # 15-806
ART. 9099 - # 15-808
ART. 9099 - # 15-808

**Kl. (cl.) WX8802-D,
WX8702-D**

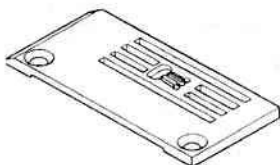

ART. 9102/1 - # 14-818 (7/32")
ART. 9102/2 - # 14-819 (1/4")



ART. 9096 - # 15-807
ART. 9096 - # 15-807



ART. 9099 - # 15-808
ART. 9099 - # 15-808

**Kl. (cl.) WX8803-D,
WX8703-D**

Stichplatten und Transporteure für NECCHI (needle plates and feed dog for NECCHI)

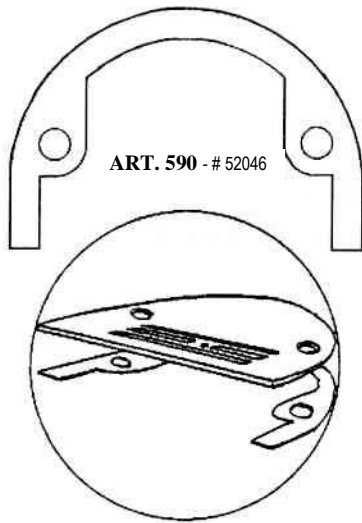

ART. 590 - # 52046

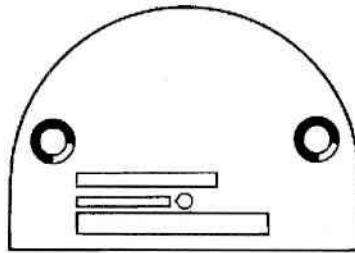

ART. 585/1 - Ø klein (small) # 42611
ART. 585/2 - Ø mittel (medium) # 42611
ART. 585/3 - Ø groß (large) # 42611

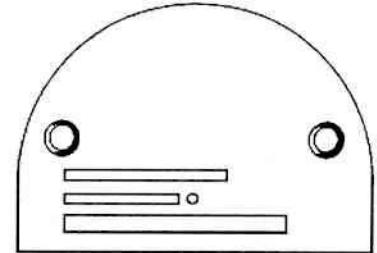

ART. 586 - # 956020-0-10 für Kl. 885, 885-261

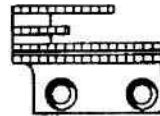

ART. 600
42600

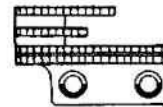

ART. 601
42600-0-20

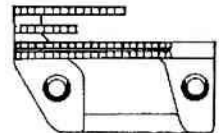

ART. 602 - # 956492-0-00
für Kl. 885-261 Fadenabschneider
(for cl. 885-261 thread trimmer)

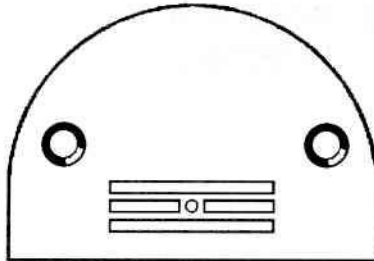

ART. 590 - # 52046

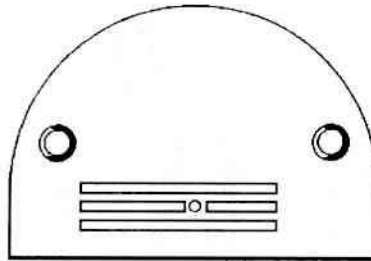

ART. 589 - # 52046-0-20
für Kl. 885-103, 263, 463, 261 etc.
(for cl. 885-103, 263, 463, 261 etc.)

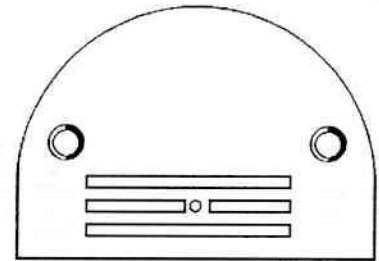

ART. 614 - # 956652-0-00
mittel (medium)

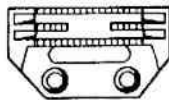

ART. 605
122622

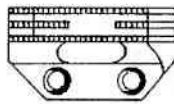

ART. 599
122622-0-20

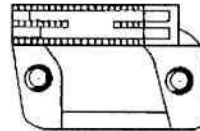

ART. 608 - # 186622-0-20
Fadenabschneider (thread trimmer)

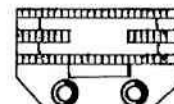

ART. 628
956654

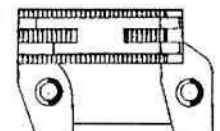

ART. 629 - # 956655-0-00
Fadenabschneider (thread trimmer)

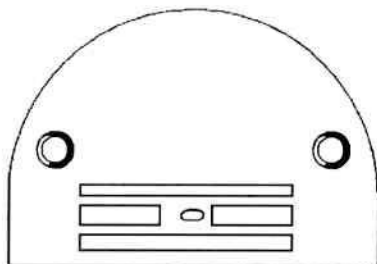

ART. 641 - # 956515-0-00 (jeans)

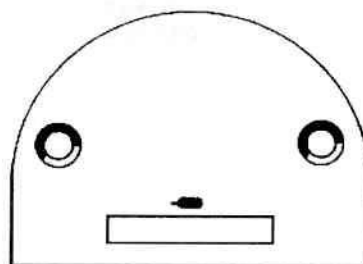

ART. 603 - # 956016-0-20

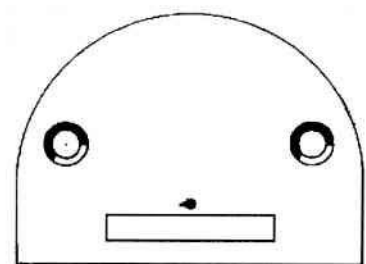

ART. 609 - # 956528-0-00
für Kl. 815-263 (for cl. 815-263)

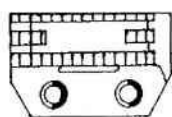

ART. 642
956516-0-00

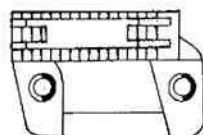

ART. 643 - # 956534-0-00
Fadenabschneider (thread trimmer)

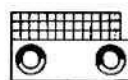

ART. 604
956017-0-20

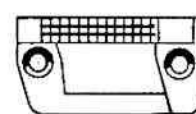

ART. 611 - # 956529-0-00
für Kl. 815-263 (for cl. 815-263)

Stichplatten und Transporteure für NECCHI (needle plates and feed dog for NECCHI)

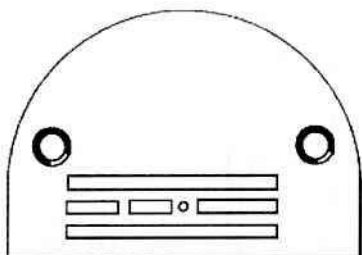

ART. 415/1 - Ø klein (small) # 956376

ART. 415/2 - Ø mittel (medium) # 956376

ART. 415/3 - Ø groß (large) # 956376

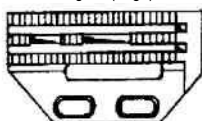

ART. 430 - # 956377

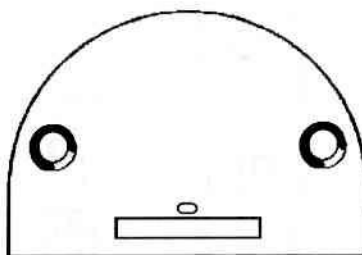

ART. 595 - # 52730

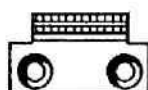

ART. 610
2728

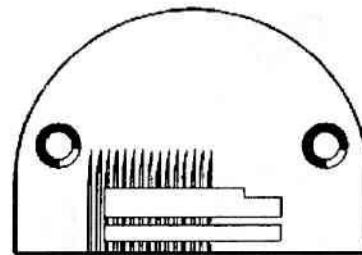

ART. 620 - # 956334

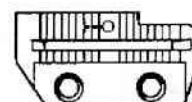

ART. 635
95633

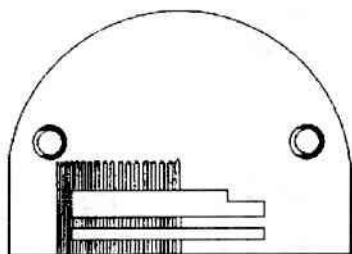

ART. 621 - # 956493-0-00
für Kl. 881-260 (for cl. 881-260)

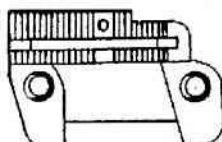

ART. 636 - # 956491-0-00
Fadenabschneider (thread trimmer)

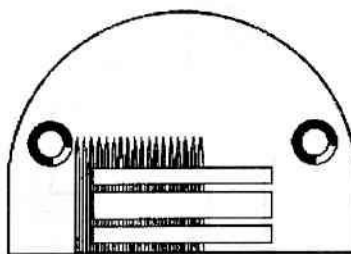

ART. 625 - # 146111

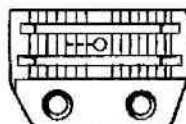

ART. 640 - # 146622

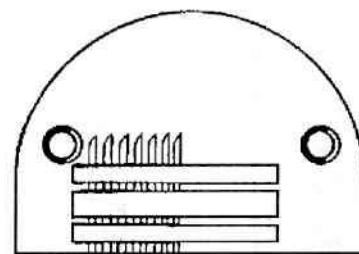

ART. 622 - # 956526-0-00
Kl. 831; 881 (cl. 831; 881)

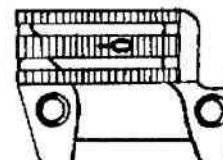

ART. 637 - # 956527-0-00
Kl. 831; 881 Fadenabschneider (cl. 831; 881 thread trimmer)

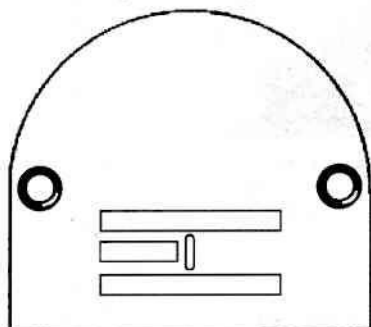

ART. 645 - # 110111

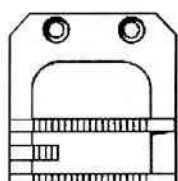

ART. 660 - # 956046

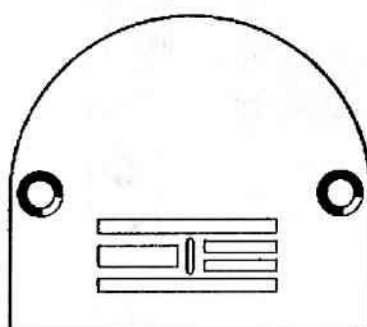

ART. 650 - # 956141

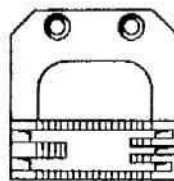

ART. 665 - # 956142

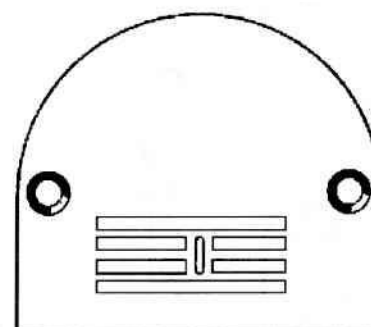



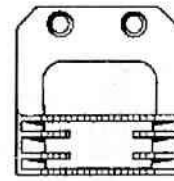





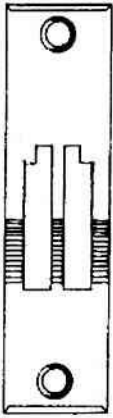

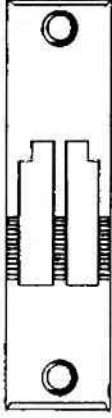
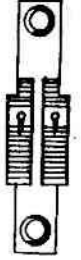
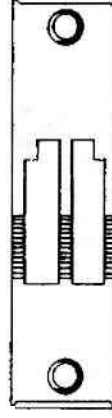
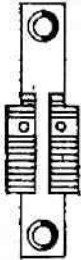
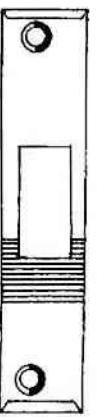
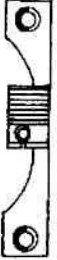
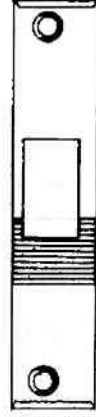

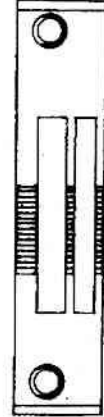
ART. 655 - # 956190

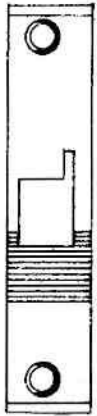

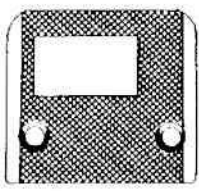
ART. 670 - # 956220

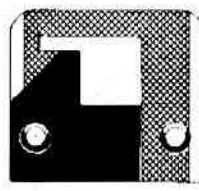
Stichplatten und Transporteure für NECCHI (needle plates and feed dog for NECCHI)

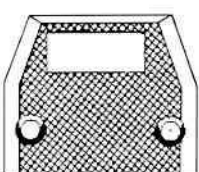
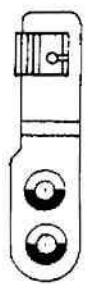
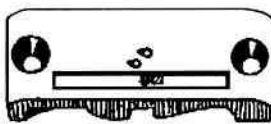
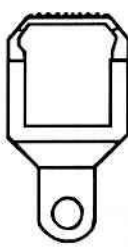
 ART. 1868 # 30726-0-00 4,8 mm	Kl. 921 und 925 (cl. 921 and 925)  ART. 1869 # 30721-0-00 4,8 mm	 ART. 1870 # 961040-0-00 6 mm	Kl. 921 und 925 (cl. 921 and 925)  ART. 1871 # 961041-0-00 6 mm	 ART. 1870 # 961040-0-00 6,4 mm	Kl. 921 und 925 (cl. 921 and 925)  ART. 1873 # 961041-0-00 6,4 mm
 ART. 1874 # 155111-0-00	Kl. 902-155 (cl. 902-155)  ART. 1875 # 155622-0-00	 ART. 1876 # 971285-0-00	Kl. 902-155 (cl. 902-155)  ART. 1877 # 971286-0-00	 ART. 1878 # 956567-0-00	Kl. 956-101 (cl. 956-101)  ART. 1879 # 956566-0-00
 ART. 1880 # 104111	Kl. 902-100 (cl. 902-100)  ART. 1881 # 104622	 ART. 5600 # 916094-0-00 Kl. 840-100 (cl. 840-100)	 ART. 5605 # 916093-0-00 Kl. 840-100 (cl. 840-100)	 ART. 5610 # 109111-0-00 Kl. 840-134 (cl. 840-134)	 ART. 5615 # 109622-0-00 Kl. 840-134 (cl. 840-134)
 ART. 5620 # 956518 Kl. 840-130 (cl. 840-130)	 ART. 5625 # 956519 Kl. 840-130 (cl. 840-130)	<p style="text-align: center;">Kl. (cl.) 930-159</p>  ART. 5603/1 1,2 mm ART. 5603/3 1,6 mm		 ART. 5604/1 1,2 mm ART. 5604/3 1,6 mm	

Stichplatten und Transporteure für PEGASUS (needle plates and feed dog for PEGASUS)

Kl. W541; W561; W644; W664 (cl. W541; W561; W644; W664)

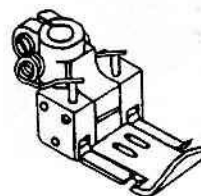
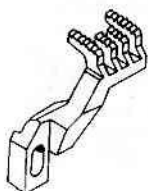
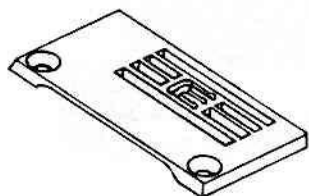

ART. 10250	-# 257015B24	ART. 10316	-# 257253-16F	ART. 10381	-# 257317A24	ART. 10437	-# 257421-64
ART. 10251	-# 257015B32	ART. 10318	-# 257254-16F	ART. 10382	-# 257317A32	ART. 10424	-# 257422-32
ART. 10252	-# 257015B40	ART. 10305	-# 257258-16F	ART. 10383	-# 257318A40	ART. 10425	-# 257423-40
ART. 10253	-# 257015B48	ART. 10306	-# 257259-16F	ART. 10384	-# 257318A48	ART. 10426	-# 257423-48
ART. 10256	-# 257016B48	ART. 10309	-# 257260-16F	ART. 10385	-# 257319A56	ART. 10427	-# 257424-56
ART. 10254	-# 257017B56	ART. 10310	-# 257261-16F	ART. 10386	-# 257319A64	ART. 10428	-# 257424-64
ART. 10255	-# 257017B64	ART. 10311	-# 257262-16F	ART. 10387	-# 257320A48	ART. 10429	-# 257425-56
ART. 10257	-# 257018B56	ART. 10321	-# 257266-16F	ART. 10388	-# 257321A56	ART. 10430	-# 257425-64
ART. 10258	-# 257018B64	ART. 10322	-# 257267-16F	ART. 10389	-# 257321A64	ART. 10363	-# 257460-24
ART. 10259	-# 257029B24	ART. 10323	-# 257268-16F	ART. 10372	-# 257322A24	ART. 10364	-# 257460-32
ART. 10260	-# 257029B32	ART. 10307	-# 257289-16F	ART. 10373	-# 257322A32	ART. 10365	-# 257460-40
ART. 10261	-# 257029B40	ART. 10308	-# 257290-16F	ART. 10374	-# 257322A40	ART. 10366	-# 257460-48
ART. 10262	-# 257029B48	ART. 10312	-# 257291-16F	ART. 10375	-# 257322A48	ART. 10367	-# 257460-56
ART. 10263	-# 257030B40	ART. 10313	-# 257292-16F	ART. 10376	-# 257324A56	ART. 10368	-# 257460-64
ART. 10264	-# 257030B48	ART. 10314	-# 257293-16F	ART. 10377	-# 257324A64	ART. 10369	-# 257461-48
ART. 10267	-# 257031B48	ART. 10315	-# 259200-16F	ART. 10378	-# 257325A48	ART. 10370	-# 257461-56
ART. 10265	-# 257032B56	ART. 10317	-# 259201-16F	ART. 10379	-# 257326A56	ART. 10371	-# 257461-64
ART. 10266	-# 257032B64	ART. 10319	-# 259214-16F	ART. 10380	-# 257326A64	ART. 10354	-# 257462-24
ART. 10268	-# 257033B56	ART. 10320	-# 259215-16F	ART. 10415	-# 257327A24	ART. 10355	-# 257462-32
ART. 10269	-# 257033B64	ART. 10324	-# 259216-16F	ART. 10416	-# 257327A32	ART. 10356	-# 257462-40
ART. 10294	-# 257049B24	ART. 10325	-# 259217-16F	ART. 10417	-# 257328A40	ART. 10357	-# 257462-48
ART. 10295	-# 257049B32	ART. 10326	-# 259218-16F	ART. 10418	-# 257328A48	ART. 10358	-# 257462-56
ART. 10296	-# 257050B40			ART. 10419	-# 257329A56	ART. 10359	-# 257462-64
ART. 10297	-# 257050B48			ART. 10420	-# 257329A64	ART. 10360	-# 257463-48
ART. 10300	-# 257051B48			ART. 10421	-# 257330A48	ART. 10361	-# 257463-56
ART. 10298	-# 257052B56			ART. 10422	-# 257331A56	ART. 10362	-# 257463-64
ART. 10299	-# 257052B64			ART. 10423	-# 257331A64	ART. 10405	-# 257467-32
ART. 10301	-# 257053B56			ART. 10406	-# 257332A24	ART. 10397	-# 257467-40
ART. 10302	-# 257053B64			ART. 10407	-# 257332A32	ART. 10398	-# 257467-48
ART. 10270	-# 257087B40			ART. 10408	-# 257333A40	ART. 10399	-# 257467-56
ART. 10271	-# 257087B48			ART. 10409	-# 257333A48	ART. 10400	-# 257467-64
ART. 10274	-# 257088B48			ART. 10410	-# 257334A56	ART. 10401	-# 257468-48
ART. 10277	-# 257089B56			ART. 10411	-# 257334A64	ART. 10402	-# 257468-56
ART. 10278	-# 257089B64			ART. 10412	-# 257335A48	ART. 10403	-# 257468-64
ART. 10275	-# 257090B56			ART. 10413	-# 257336A56	ART. 10404	-# 257469-32
ART. 10276	-# 257090B64			ART. 10414	-# 257336A64	ART. 10390	-# 257469-40
ART. 10279	-# 257091B40			ART. 10431	-# 257418-32	ART. 10391	-# 257469-48
ART. 10280	-# 257091B48	ART. 10327	-# 257206-16F	ART. 10432	-# 257419-40	ART. 10392	-# 257469-56
ART. 10283	-# 257092B48	ART. 10328	-# 257207-16F	ART. 10433	-# 257419-48	ART. 10393	-# 257469-64
ART. 10281	-# 257093B56	ART. 10331	-# 257214-16F	ART. 10434	-# 257420-56	ART. 10394	-# 257470-48
ART. 10282	-# 257093B64	ART. 10332	-# 257215-16F	ART. 10435	-# 257420-64	ART. 10395	-# 257470-56
ART. 10284	-# 257094B56	ART. 10333	-# 257216-16F	ART. 10436	-# 257421-56	ART. 10396	-# 257470-64
ART. 10285	-# 257094B64	ART. 10339	-# 257220-16F				
ART. 10289	-# 257096B56	ART. 10340	-# 257221-16F				
ART. 10290	-# 257096B64	ART. 10341	-# 257222-16F				
ART. 10291	-# 257097B56	ART. 10337	-# 259102-16F				
ART. 10292	-# 257097B54	ART. 10338	-# 259103-16F				
ART. 10286	-# 257098B32	ART. 10342	-# 259104-16F				
ART. 10287	-# 257098B40	ART. 10343	-# 259105-16F				
ART. 10288	-# 257099B48	ART. 10344	-# 259106-16F				



Stichplatten und Transporteure für PEGASUS (needle plates and feed dog for PEGASUS)

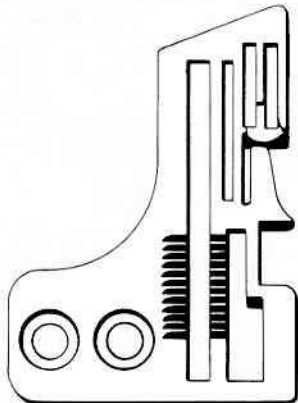

ART. M130001
205 321

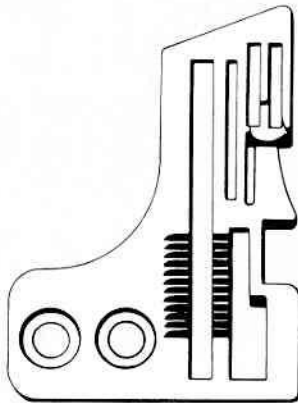

ART. M130002
205 322



ART. M130007
208 336



ART. M130008
208 338

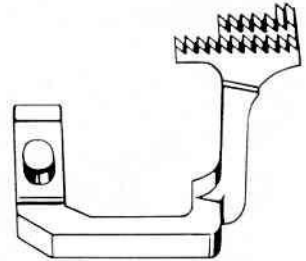

ART. M130009
204 907

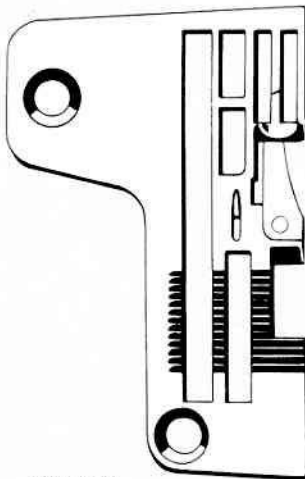

ART. M130003
204 252 B

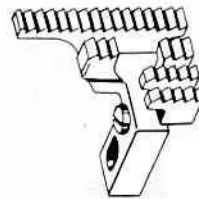

ART. M130010
208 063

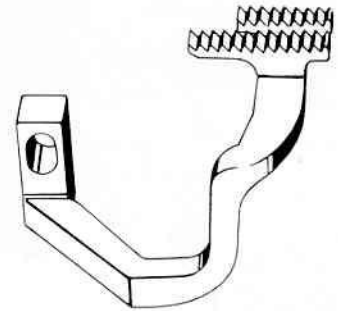

ART. M130011
208 215

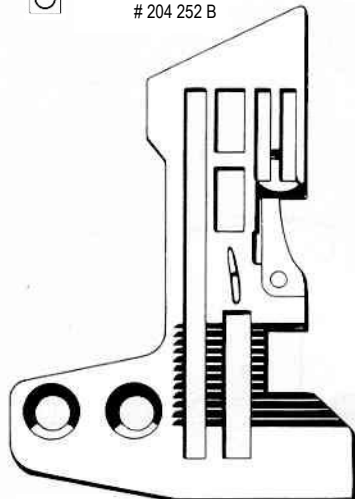

ART. M130005
210 846

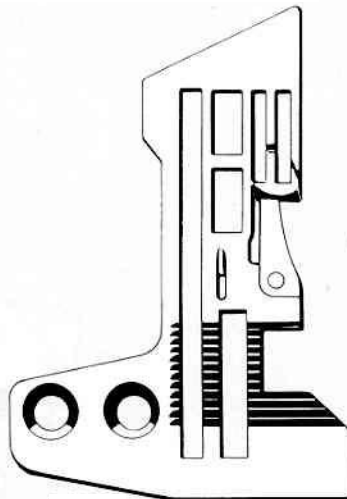

ART. M130006
210 851

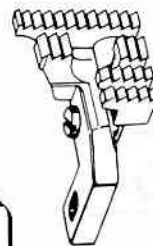

ART. M130012
210 581

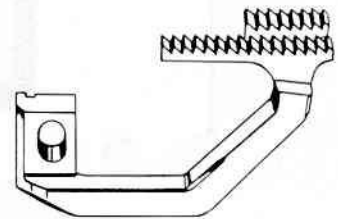

ART. M130013
210 494

Stichplatten und Transporteure für PEGASUS (needle plates and feed dog for PEGASUS)

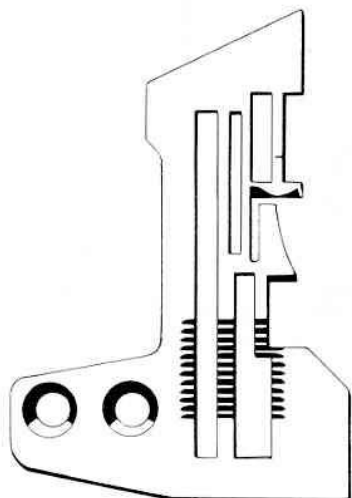

ART. M130014
210 787

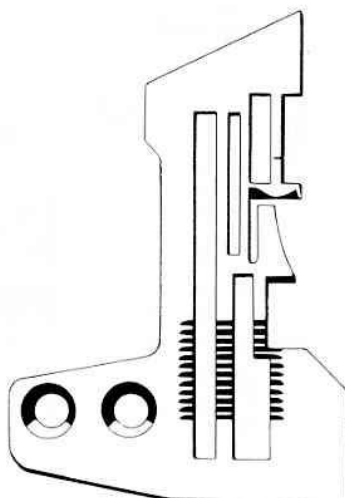

ART. M130015
210 788

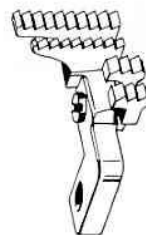

ART. M130017
210 568

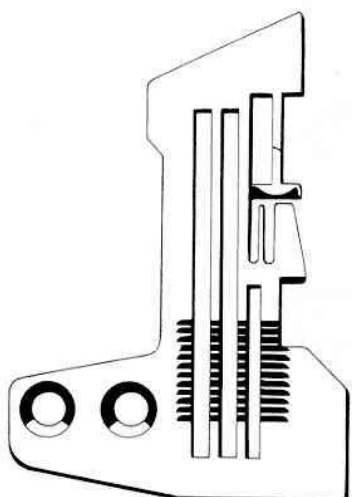

ART. M130016
210 810

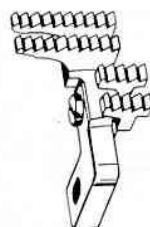

ART. M130019
210 575

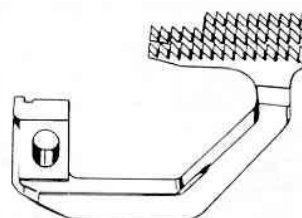

ART. M130020
210 445

Stichplatten und Transporteure für PFAFF (needle plates and feed dog for PFAFF)

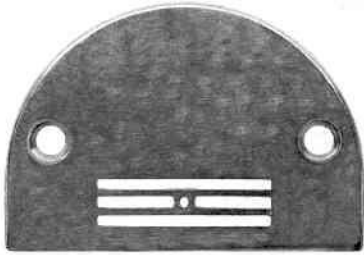

ART. 681 - # 48522-04 B Kl. 463 (cl. 463)
fein (for shirt production)

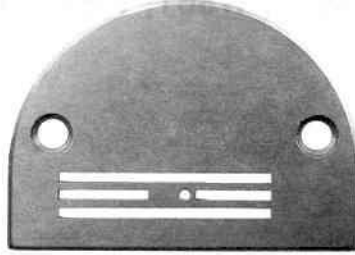

ART. 683 - # 91-048664-04B 1,6
Kl. 463 (cl. 463)
fein (for shirt production)

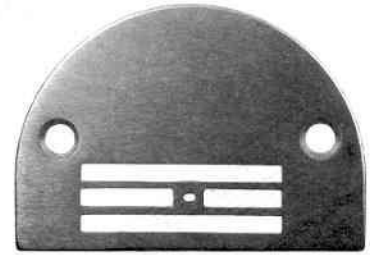

ART. 686 - # 91-058048-04 B
Kl. 463, mittel (cl. 463, medium)

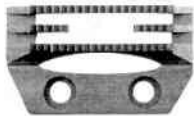

ART. 682 - # 47461 Kl. 463 (cl. 463)
fein (for shirt production)

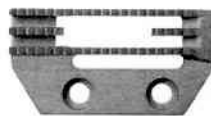

ART. 684 - # 47298 A Kl. 463 (cl. 463)
fein (for shirt production)

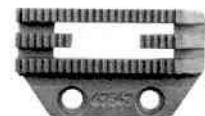

ART. 764 - # 91-047547-1,5
Kl. 463, mittel (cl. 463, medium)

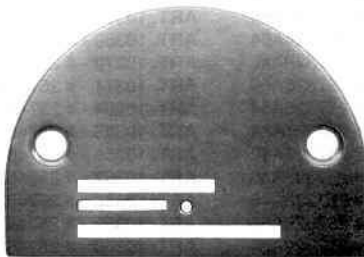

ART. 675 - # 26096

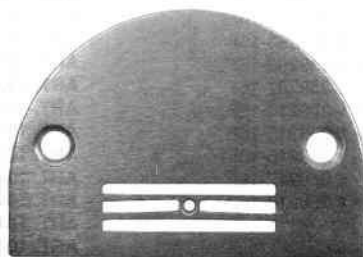

ART. 680 - # 26209

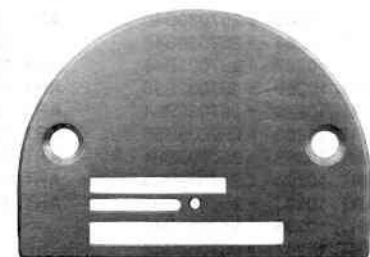

ART. 685 - # 26272



ART. 730
26095

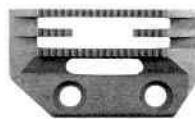

ART. 400
52031



ART. 700
26271

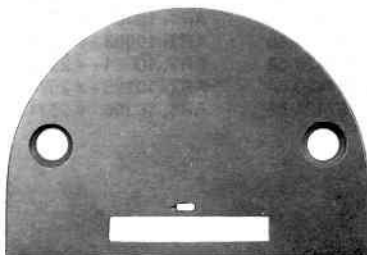

ART. 710 - # 46397

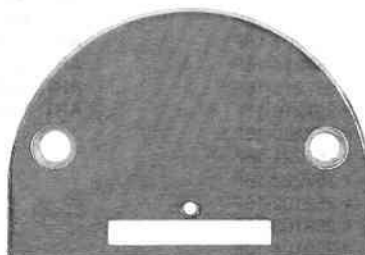

ART. 711 - # 91-048673-04
Kl. 463 Fadenabschneider (cl. 463 thread trimmer)

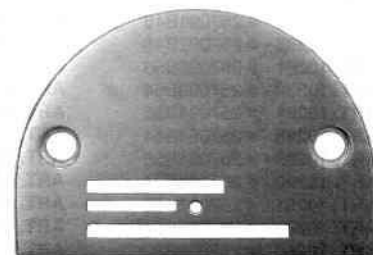

ART. 715 - # 48517



ART. 725 - # 46398



ART. 725 - # 46398



ART. 730 - # 26095

Stichplatten und Transporteure für PFAFF (needle plates and feed dog for PFAFF)

Kl. 138; 238; 438 (cl. 138; 238; 438)

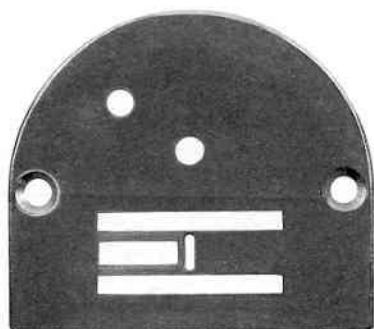

ART. 735 - # 46313

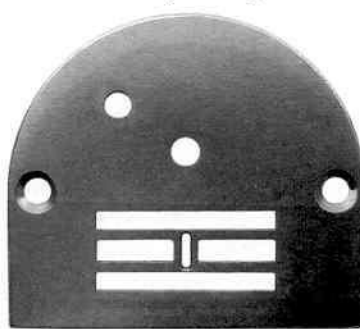

ART. 740 - # 26512

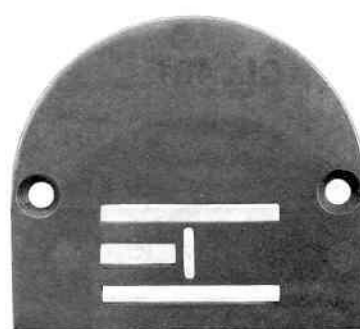

ART. 745 - # 26544

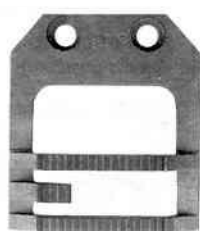

ART. 750
26883

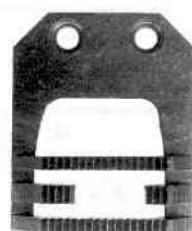

ART. 755
26511

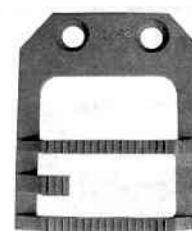

ART. 760
26978

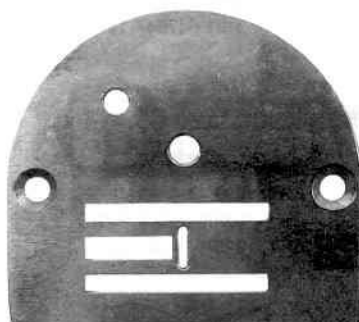

ART. 765 - # 26888

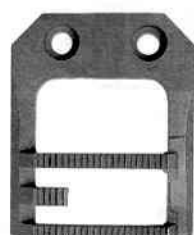

ART. 775 - # 26891

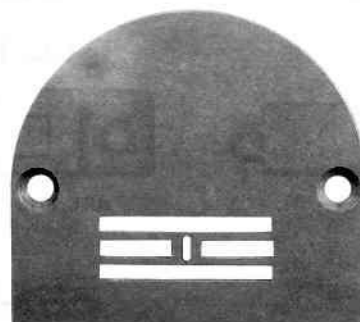

ART. 770 - # 26665



ART. 780 - # 26664

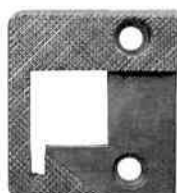

ART. 781 - # 46498
Kl. 335 (cl. 335)



ART. 783 - # 46497 Kl. 335 (cl. 335)

Kl. 438 Miederwaren (cl. 438 lingerie)

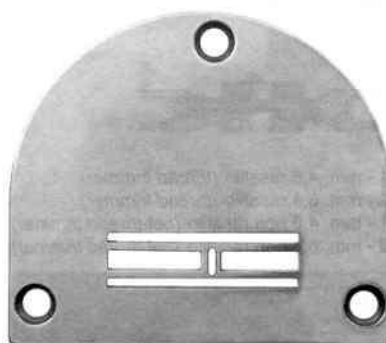

ART. 771 - # 91-058140 3,5 mm

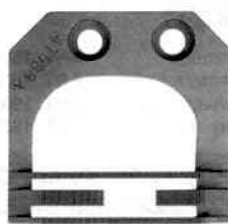

ART. 772 - # 91-047588A

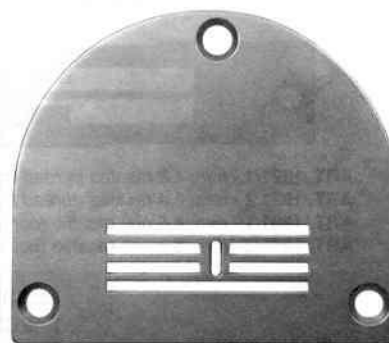

ART. 773 - # 91-058217 4,5 mm

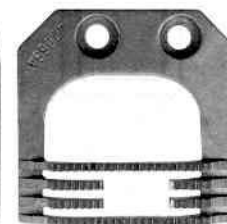

ART. 774 - # 91-047666A

Stichplatten und Transporteure für PFAFF (needle plates and feed dog for PFAFF)

Kl. 461 (cl. 461)

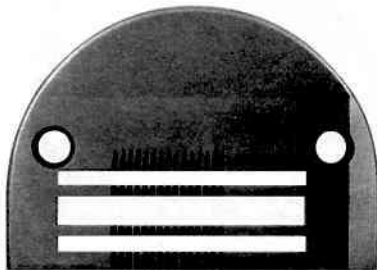

ART. 766 - jeans

Kl. 483 (cl. 483)

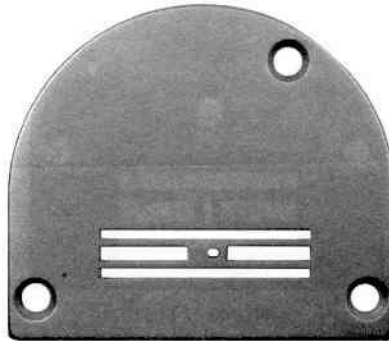

ART. 761 - # 91-058130-24-001
Kl. 483 (cl. 483)
fein (for shirt production)

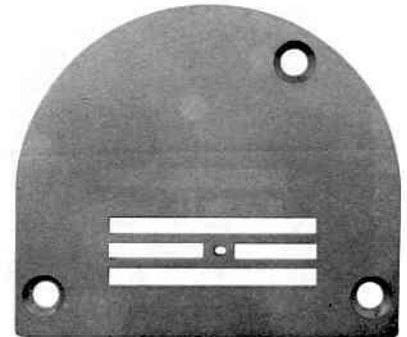

ART. 762 - # 91-058132-04 x 1,6
Kl. 483, mittel (cl. 483, medium)

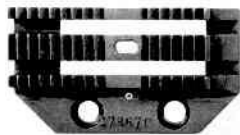

ART. 768 - # 47867 C
jeans



ART. 763 - # 47350-A

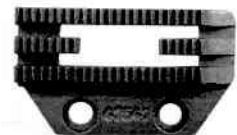

ART. 764
91-047547-1,5

Kl. 145; 146; 545; 1245 (cl. 145; 146; 545; 1245)



ART. 1910 - # 26746 C

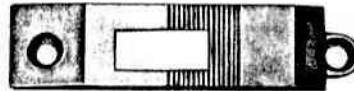

ART. 1915 - # 48537 C & D



ART. 1920 - # 45592 C
für Bandenfasser (for binder)
ART. 1920/1 - # 45592 C



ART. 1925 - # 26745 B



ART. 1930 - # 47181 C



ART. 1935 - # 45591 C



ART. 1940 - # 26745 C

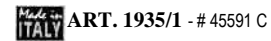

ART. 1935/1 - # 45591 C

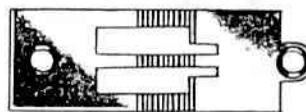

ART. 1911/1 - # 91-046735-04 - 4,8 mm
ART. 1911/2 - # 91-046715-04 - 6,4 mm

Kl. 142 (cl. 142)

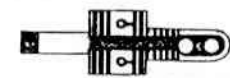

ART. 1912/1 - # 91-046714-04 - 4,8 mm
ART. 1912/2 - # 91-046714-04 - 6,4 mm

Kl. 194; 594 (cl. 194; 594)

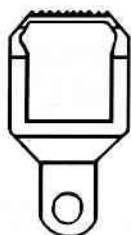

ART. 2011
40358 x 1,6



ART. 1921/1 - 4,8 mm, Fadenabschneider (4,8 mm, thread trimmer)
ART. 1921/2 - 6,4 mm, Fadenabschneider (6,4 mm, thread trimmer)
ART. 1931/1 - 4,8 mm, ohne Fadenabschneider
(4,8 mm, ohne thread trimmer)
ART. 1931/2 - 6,4 mm, Fadenabschneider
(6,4 mm, without thread trimmer)

Kl. 442 (cl. 442)



ART. 1922/1 - 4,8 mm, Fadenabschneider (4,8 mm, thread trimmer)
ART. 1922/2 - 6,4 mm, Fadenabschneider (6,4 mm, thread trimmer)
ART. 1932/1 - 4,8 mm, ohne Fadenabschneider
(4,8 mm, without thread trimmer)
ART. 1932/2 - 6,4 mm, ohne Fadenabschneider
(6,4 mm, without thread trimmer)

Stichplatten und Transporteure für RIMOLDI (needle plates and feed dog for RIMOLDI)

Kl. B27; B28, 227, 228, 327, 527, 627 (cl. B27; B28, 227, 228, 327, 527, 627)

ART. 940
202504-0-11
4,1 mm

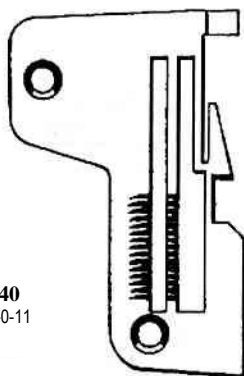

ART. 948
202757-0-00



ART. 949
202758-0-00



ART. 951
202061-0-10

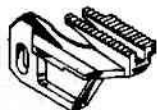

ART. 2708
202053-0-10



ART. 2799
202057-0-10



ART. 951
202061-0-10

ART. 935
202148-0-10
4,6 mm

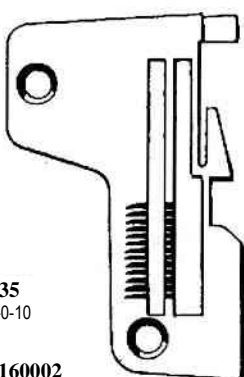

ART. 948
202757-0-00



ART. 949
202758-0-00



ART. 951
202061-0-10



ART. 2708
202053-0-10



ART. 2799
202057-0-10



ART. 951
202061-0-10

 **ART. M160002**
202148-0-10

ART. 2706
202507-0-10
5 mm

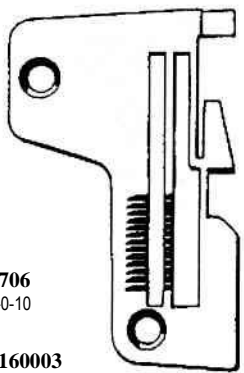

ART. 948
202757-0-00



ART. 949
202758-0-00



ART. 951
202061-0-10



ART. 2708
202053-0-10



ART. 2799
202057-0-10



ART. 951
202061-0-10

 **ART. M160003**
202507-0-10

ART. 2707
202590-0-10
6 mm

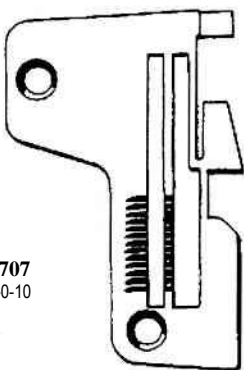

ART. 948
202757-0-00



ART. 949
202758-0-00



ART. 951
202061-0-10

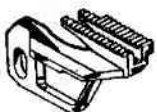

ART. 2708
202052-0-10



ART. 2799
202057-0-10



ART. 951
202061-0-10

Stichplatten und Transporteure für RIMOLDI (needle plates and feed dog for RIMOLDI)

Kl. 29, 229, 327, 329, 527, 529, 629 (cl. 29, 229, 327, 329, 527, 529, 629)

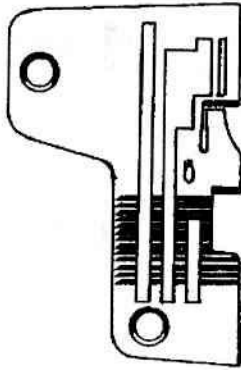

ART. 938
204867-0-11

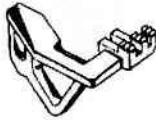

ART. 2709
204848-0-10



ART. 2792
202609-0-10



ART. 2711
204852-0-10

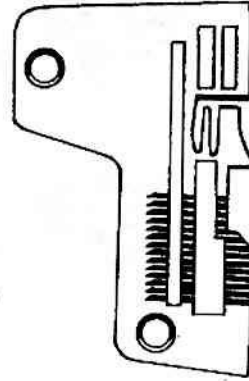

ART. 942
203549-0-11



ART. 2712
203532-0-10



ART. 2795
203539-0-10



ART. 2790
203544-0-10

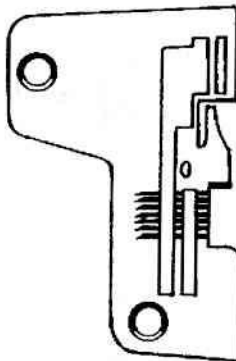

ART. 944
204698-0-12



ART. 2713
204667-0-10



ART. 2714
204819-0-10



ART. 2796
204669-0-10

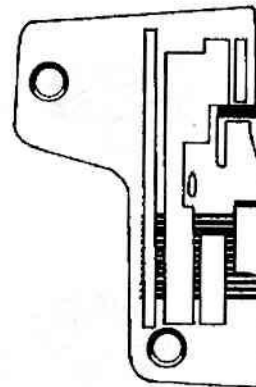

ART. 946
205026-0-11

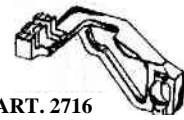

ART. 2716
205010-0-10

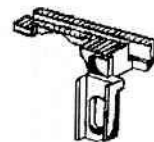

ART. 2717
205014-0-10



ART. 2792
202609-0-10

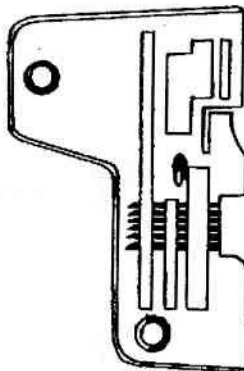

ART. 965
205025-0-12

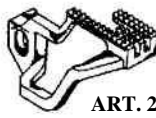

ART. 2718
205060-0-13



ART. 2797
205065-0-10



ART. 2792
202609-0-10



ART. 2719
205007-0-13



ART. 2721
205011-0-10



ART. 2792
202609-0-10

Stichplatten und Transporteure für RIMOLDI (needle plates and feed dog for RIMOLDI)

Kl. B27; B28; B29, 227, 228, 327, 329, 527, 529, 627

(cl. B27; B28; B29, 227, 228, 327, 329, 527, 539, 627)

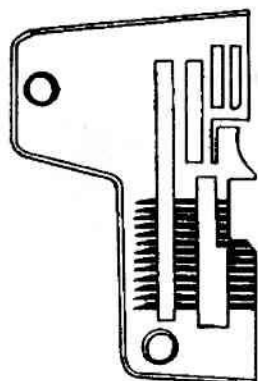

ART. 975
203035-0-12



ART. 2724
203028-0-10

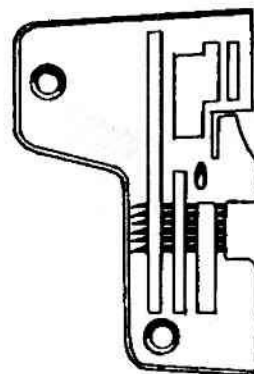

ART. 970
204864-0-13



ART. 2722
204846-0-13

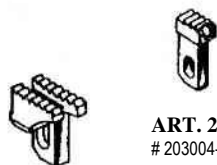

ART. 2791
203004-0-10



ART. 2792
202609-0-10



ART. 2798
203031-0-10



ART. 2723
204850-0-10

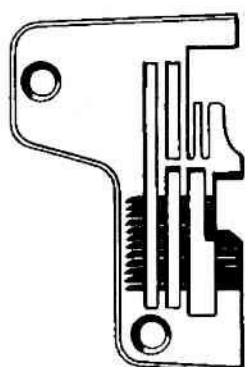

ART. 945
203547-0-11

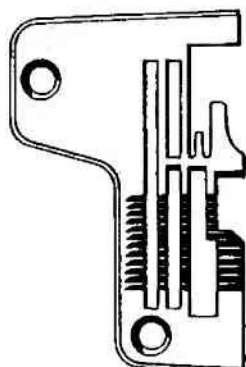

ART. 950
204026-0-11

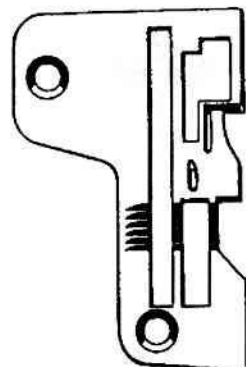

ART. 955
204695-0-10

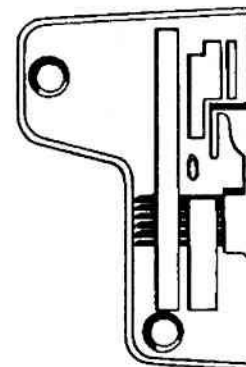

ART. 960
204695-0-11



ART. M160007
203547-0-10



ART. M160008
204695-0-11

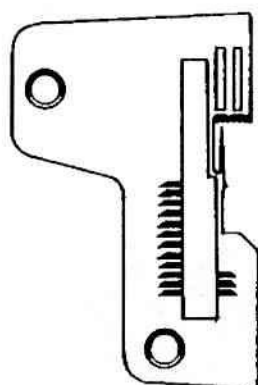

ART. 2726
202636-0-11

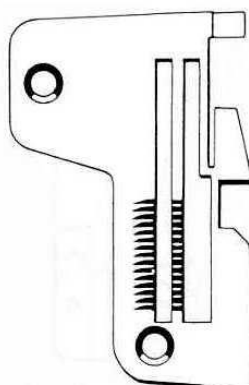

ART. M160004
202 508-0-10

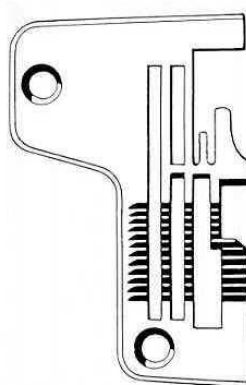

ART. M160006
204 026-0-10

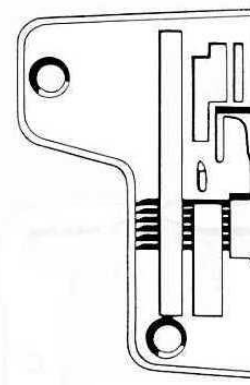

ART. M160009
204 809-0-00

Stichplatten und Transporteure für RIMOLDI (needle plates and feed dog for RIMOLDI)

Kl. B63; 63; 263 (cl. B63; 63; 263)

Kl. 263-17-2MD-01
(cl. 263-17-2MD-01)

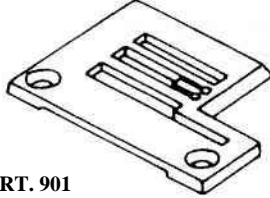

ART. 901
301759-0-10 - 3,5 mm

ART. 904
301760-0-10 - 3,5 mm



ART. 907
300104-0-10

ART. 908
301755-0-10



ART. 906
300102-0-10

Kl. 263-17-3MD-07
(cl. 263-17-3MD-07)

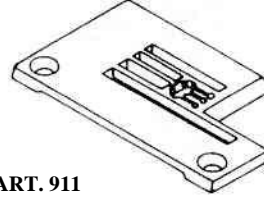

ART. 911
301764-0-10 - 6 mm

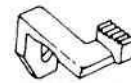

ART. 913
300135-0-10



ART. 912
300133-0-10

Kl. 263-16-2MD-18
(cl. 263-16-2MD-18)

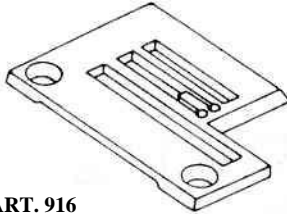

ART. 916
301765-0-10 - 4,5 mm

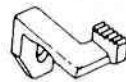

ART. 907
300104-0-10



ART. 906
300102-0-10

Kl. 263-46-3MD; 263-10-3MD
(cl. 263-46-3MD; 263-10-3MD)

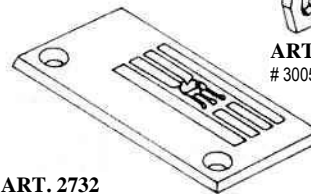

ART. 2732
302416-0-10 - 6 mm

ART. 2733
302467-0-10 - 5 mm



ART. 919
300564-0-12



ART. 918
300563-0-12

Kl. 263-06-3MD-02
(cl. 263-06-3MD-02)

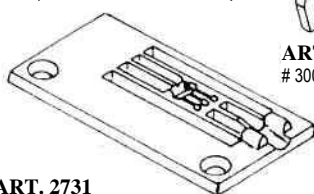

ART. 2731
302408-0-10 - 6 mm



ART. 923
300576-0-11



ART. 918
300563-0-12

Kl. 263-34-2DR-20
(cl. 263-34-2DR-20)

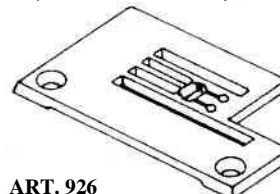

ART. 926
302754-0-10 - 3 mm

ART. 927
302811-0-10 - 3,5 mm



ART. 931
302798-0-10



ART. 928
302796-0-10

Kl. 263-34-3DR-16
(cl. 263-34-3DR-16)

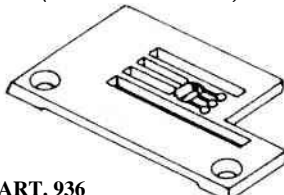

ART. 936
302735-0-10 - 6 mm

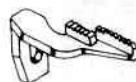

ART. 953
302797-0-10



ART. 937
302795-0-11

Stichplatten und Transporteure für SINGER (needle plates and feed dog for SINGER)

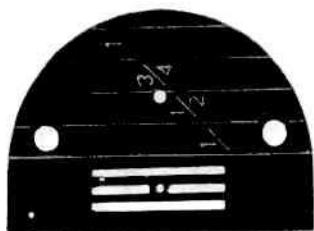

fein (for shirt production)

ART. 380/1 - Ø klein (small) # 52033

ART. 380/2 - Ø mittel (medium) # 143272

ART. 380/3 - Ø groß (large) # 52032

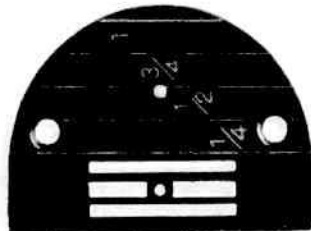

ART. 385

20160 LG



ART. 390

147150 LG



ART. 400

52031

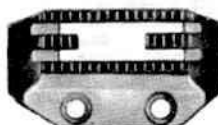

ART. 405

149159 (20159)



ART. 410

149057



ART. 415/1 - Ø klein (small) # 147346

ART. 415/2 - Ø mittel (medium) # 147388

ART. 415/3 - Ø groß (large) # 147320

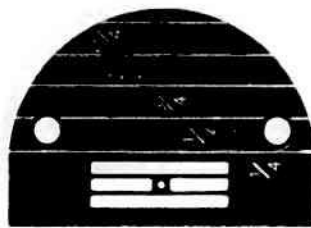

ART. 420

52145 LG

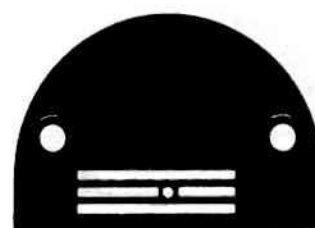

ART. 425

147328



ART. 430

147315



ART. 435

149144

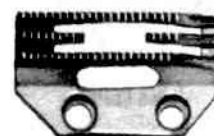

ART. 440

147327



ART. 445

44162 LG

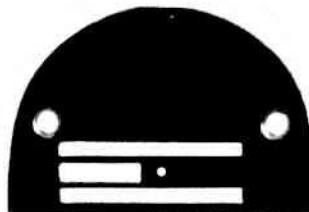

ART. 450

143175

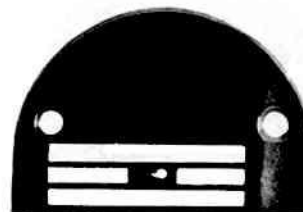

ART. 455

143169

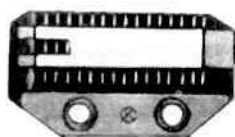

ART. 460

44158

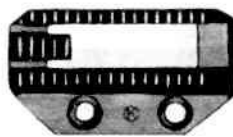

ART. 465

143174

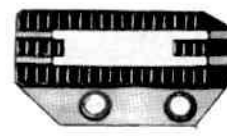

ART. 470

149165 (143165)

Stichplatten und Transporteure für SINGER (needle plates and feed dog for SINGER)

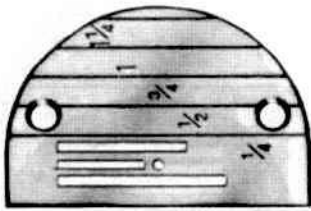

ART. 475
12482



ART. 480
143402

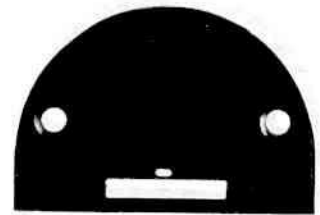

ART. 485
12438

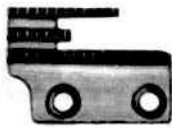

ART. 490
12481

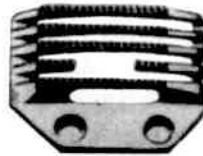

ART. 495
149009



ART. 500
12436

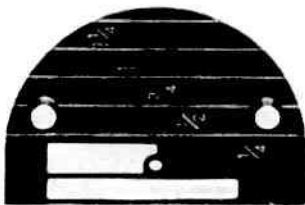

ART. 505
26605 LG

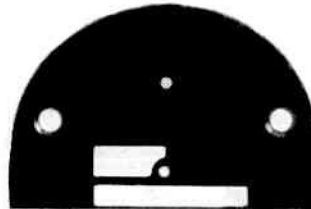

ART. 510
44137



ART. 515
127320 LG

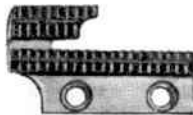

ART. 520
26603



ART. 525
44136



ART. 530
149319

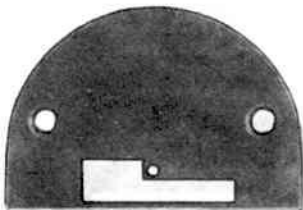

ART. 535
12411

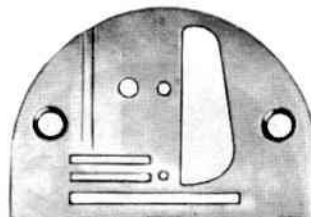

ART. 540 - kleiner Ausschnitt (small cutout) # 12442B
ART. 540/1 - mittlerer Ausschnitt (medium cutout)
ART. 540/2 - großer Ausschnitt (large cutout)

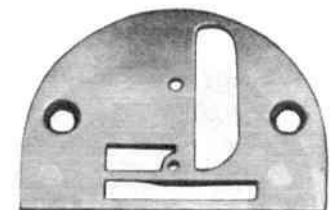

ART. 545
B 44137



ART. 550
12369

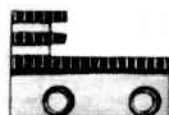

ART. 555
20002



ART. 525
44136 (149136)

Stichplatten und Transporteure für SINGER (needle plates and feed dog for SINGER)

Kl. 112W140; 121G & W 140 (cl. 112W140; 212G & W 140)

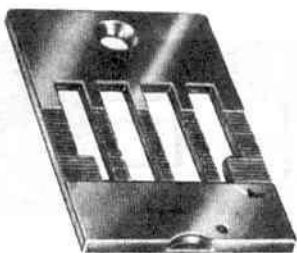

ART. 1065

In folgenden Nadelabständen erhältlich:
(available in these needle spaces:)
1/16"; 3/32"; 1/8"; 5/32"; 3/16"; 7/32"; 1/4"; 9/32"; 5/16";
11/32"; 3/8"; 7/16"; 1/2"; 9/16"; 5/8"; 3/4"; 7/8"; 1"; 1.1/8";
1.1/4"; 1.3/8"; 1.1/2"; 1.5/8"; 1.3/4"
Bei Bestellung Nadelabstand angeben
(ordering with specify needle space)

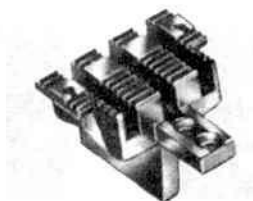

ART. 1070

*Kl. 111G & W; 211G & W
(cl. 111G & W; 211G & W)*

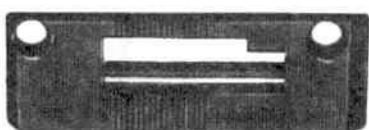

ART. 1010
240025



ART. 1015
240144



ART. 1035
240027



ART. 1025
240075



ART. 1020
240112
Nadeldurchmesser 125 und 140
(needle diametre 125 and 140)



ART. 1040
240078

*Kl. 107G & W; 307G; 457G
(cl. 107G & W; 307G; 457G)*

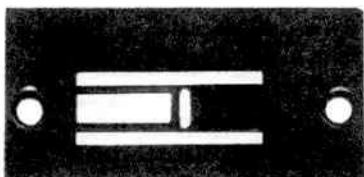

ART. 980
210600 (# 241371)
Singer 107 W



ART. 985
241372



ART. 990
210774

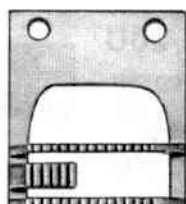

ART. 995
210518
Singer 107 W

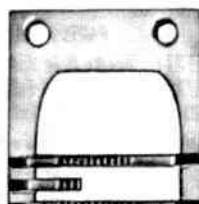

ART. 1000
241373

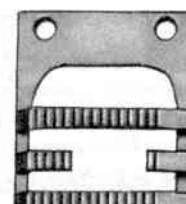

ART. 1005
210767

Stichplatten und Transporteure für SINGER (needle plates and feed dog for SINGER) Kl. 107G & W; 307G; 457G (cl. 107G & W; 307G; 457G)

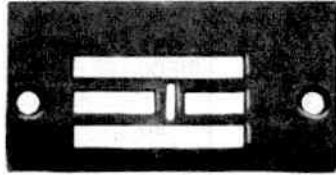

ART. 981
210603

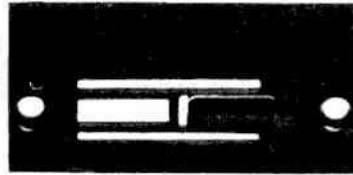

ART. 982 - # 210599
mit Nadelspitzenführung (with lace guide)

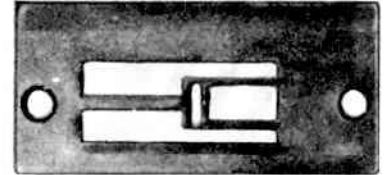

ART. 983
210601



ART. 984
210523



ART. 986
502547
Singer 107 W

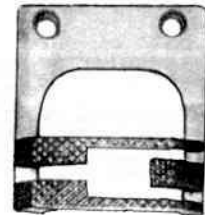

ART. 987
210521

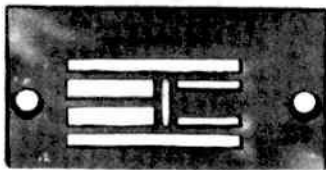

ART. 988
503605
Singer 457 W

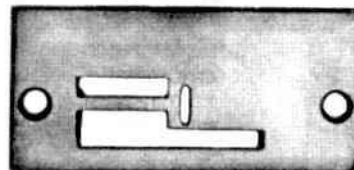

ART. 989
210596



ART. 991
503733
Singer 457G140



ART. 992
266008
Singer 107 + Singer 457

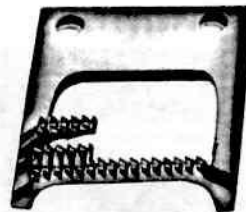

ART. 993
210516

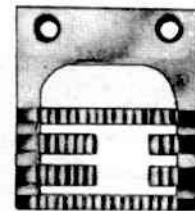

ART. 994
5037343
Singer 457G140, 143



ART. 996
503682
Singer 457G105 etc.



ART. 997
503683

Kl. 20 U
(cl. 20 U)

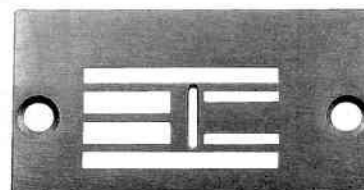

ART. 1001 # 541936

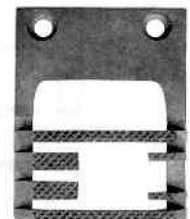

ART. 1002 - # 541647

Stichplatten und Transporteure für SINGER (needle plates and feed dog for SINGER)

Kl. 231; 253; 261; 262 (cl. 231; 253; 261; 262)



ART. 1092 - # 160411



ART. 1093
160407



ART. 1095/1 - # 146636 3/16"
ART. 1095/2 - # 146636 1/4"



ART. 1096/1 - # 146531 3/16"
ART. 1096/2 - # 146531 1/4"

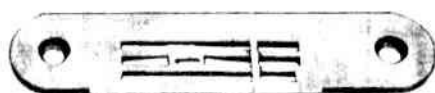

ART. 1098 - # 146248-002

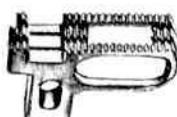

ART. 1099
142363



ART. 1117 - # 68085



ART. 1118
142388



ART. 1120/1 - # 146290 3/16"
ART. 1120/2 - # 146290 1/4"



ART. 1121/1
142375 3/16"

ART. 1121/2
142375 1/4"

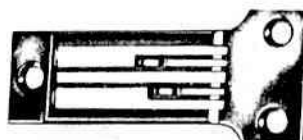

ART. 1101/1 - # 139186 3/16"
ART. 1101/2 - # 139186 1/4"



ART. 1102/1 - # 139049 3/16"
ART. 1102/2 - # 139049 1/4"



ART. 1104/1 - # 139541 3/16"
ART. 1104/2 - # 139541 1/4"



ART. 1105/1 - # 139540 3/16"
ART. 1105/2 - # 139540 1/4"

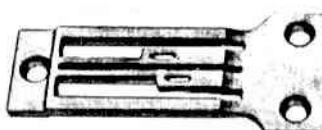

ART. 1106 - # 139385 1/4"

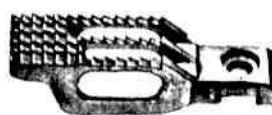

ART. 1107 - # 139382 1/4"

1/8 - 1/8



ART. 1111/1
139460 (# 139549) 3/16"

ART. 1111/2
139460 (# 139549) 1/4"



ART. 1112/1
139364 (# 139548) 3/16"

ART. 1112/2
139364 (# 139548) 1/4"

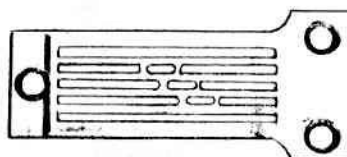

ART. 1114 - # 139500-501



ART. 1115 - # 139499-501

Kl. 519C

Fadenabschneider
(cl. 519 C thread trimmer)

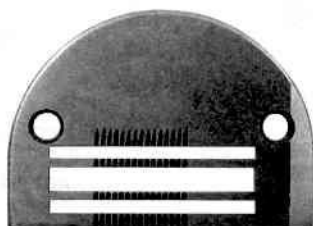

ART. 766 - # 410969
jeans



ART. 767 - # 410918
jeans

Stichplatten und Transporteure für SIRUBA (needle plates and feed dog for SIRUBA)

*RIMOLDI 427, 429 • NECCHI 604, 612, 614, 615 • SINGER 861A, 862A, 872A
SIRUBA 737, 747, 757 • W & G 504, 512, 514, 516 • MAUSER 9000 • PEGASUS E32, E52, E56*

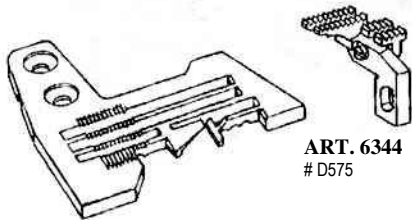

ART. 6342 4 mm
E800

ART. 6344
D575

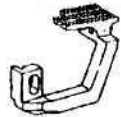

ART. 6346
H445

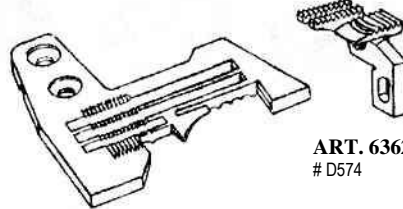

ART. 6358 4 mm # E796
ART. 6360 5 mm # E797

ART. 6362
D574

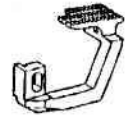

ART. 6346
H445

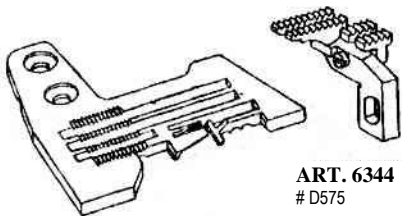

ART. 6366 4 mm # E809
ART. 6368 5 mm # E810

ART. 6344
D575

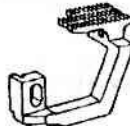

ART. 6346
H445

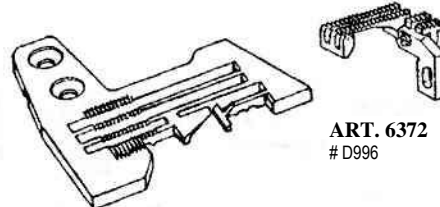

ART. 6342 4 mm
E800

ART. 6372
D996

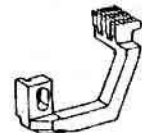

ART. 6374
D959

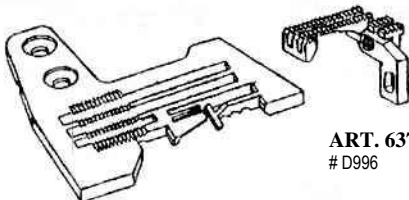

ART. 6366 4 mm # E809
ART. 6368 5 mm # E810

ART. 6372
D996

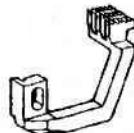

ART. 6374
H959

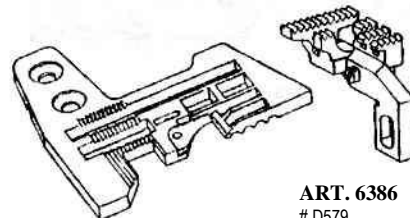

ART. 6380 3 mm # E837
ART. 6407 4 mm # E834
ART. 6384 5 mm # E839

ART. 6386
D579

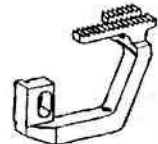

ART. 6388
H492

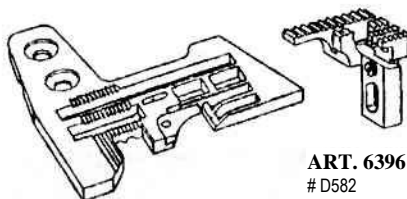

ART. 6392 5 mm # E853
ART. 6394 6 mm # E854

ART. 6396
D582

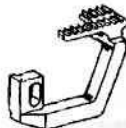

ART. 6398
H495

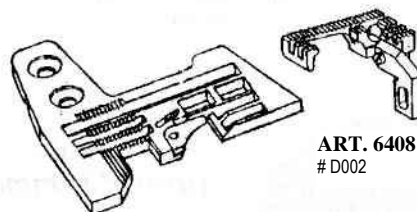

ART. 6402 3 mm # E980
ART. 6406 5 mm # E982

ART. 6408
D002

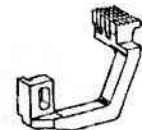

ART. 6410
H957

Stichplatten und Transporteure für SIRUBA (needle plates and feed dog for SIRUBA)

RIMOLDI 427, 429 • NECCHI 604, 612, 614, 615 • SINGER 861A, 862A, 872A
SIRUBA 737, 747, 757 • W & G 504, 512, 514, 516 • MAUSER 9000 • PEGASUS E32, E52, E56

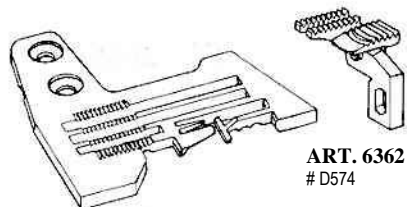

ART. 6362
D574

ART. 6381 # E804
ART. 6382 # E805

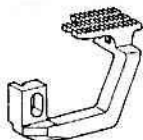

ART. 6346
H445

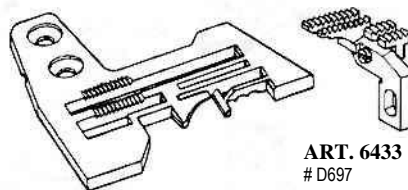

ART. 6433
D697

ART. 6387 # E786
ART. 6389 # E787

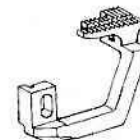

ART. 6395
H443

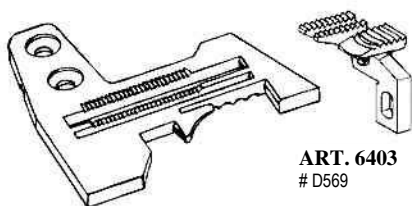

ART. 6403
D569

ART. 6399 # E783
ART. 6401 # E784

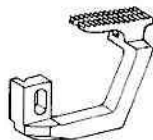

ART. 6404
H442

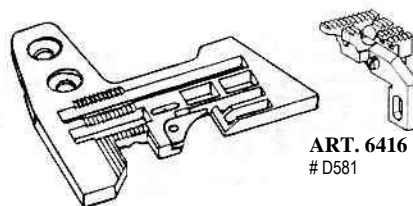

ART. 6416
D581

ART. 6413 # E845
ART. 6414 # E847
ART. 6415 # E848

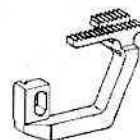

ART. 6417
H494

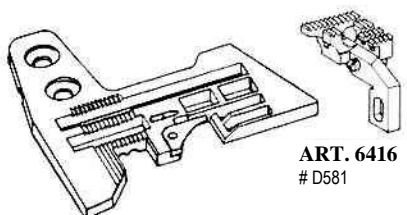

ART. 6416
D581

ART. 6418 # E851
ART. 6419 # E852

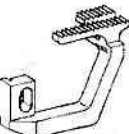

ART. 6417
H494

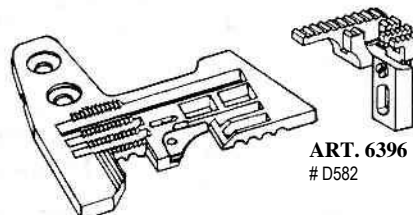

ART. 6396
D582

ART. 6421 # E859
ART. 6422 # E860
ART. 6423 # E861

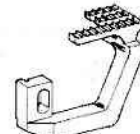

ART. 6424
H498

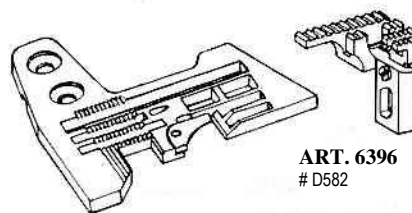

ART. 6396
D582

ART. 6425 # E865
ART. 6426 # E866

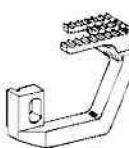

ART. 6427
H501

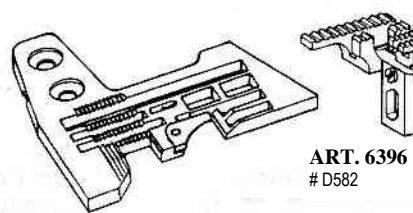

ART. 6396
D582

ART. 6429 # E868

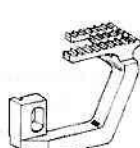

ART. 6427
H501

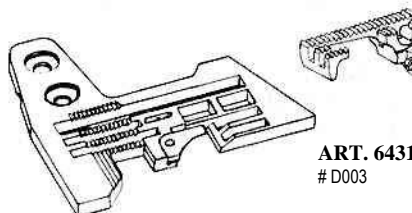

ART. 6431
D003

ART. 6430 # E986

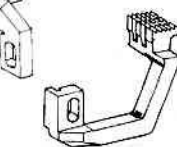

ART. 6410
H957

Zungen, einzeln
(tongue only)

ART. 6380/2 - 4 mm
ART. 6380/3 - 5 mm
ART. 6380/4 - 6 mm

Stichplatten und Transporteure für UNION SPECIAL (needle plates and feed dog for UNION SPECIAL)

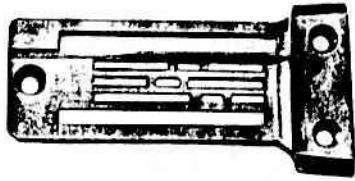

ART. 6703 # 35824 DQ-9



ART. 6704 # 35805 BR-8
ART. 6705 # 35805 DP-8



ART. 6706 # 35826 DP
ART. 6707 # 35826 DM



ART. 6708 # 35826

Kl. 35800
(cl. 35800)



ART. 6735 # 35824 AC-16

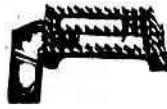

ART. 6736 # 35805 AC-16

Kl. 35800 AC
(cl. 35800 AC)

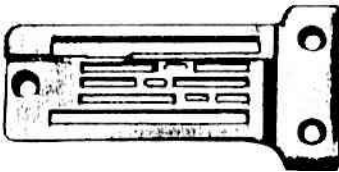

ART. 6738 # 36824 BQ-9

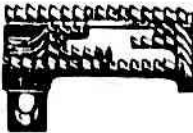

ART. 6740 # 35805 BQ-9



ART. 6741 # 35826 E

Kl. 35800 BQ, DQ
(cl. 35800 BQ, DQ)

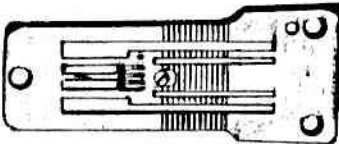

ART. 6742 # 36224 A



ART. 6743
36240



ART. 6744
36205 A



ART. 6745
36226 A

Kl. 36200
(cl. 36200)

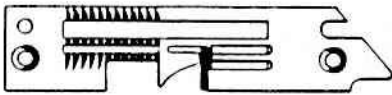

ART. 1275 # 39224 J
ART. M190005



ART. 1260 # 39224 AC 3/32"
ART. M190003



Kl. 39200
(cl. 39200)

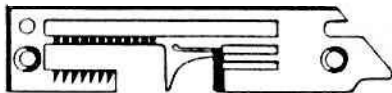

ART. 1280 # 39224 AA
ART. M190006



ART. 1265 # 39224 AC 1/8"
ART. M190004



Kl. 39500 (cl. 39500)

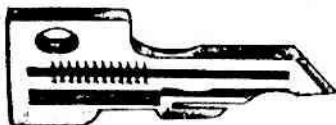

ART. 1168 # 39524 P 1/8" (AJ)
ART. M190017

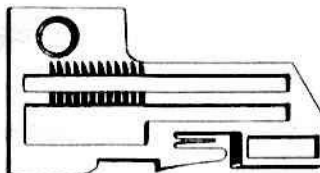

ART. 1175 # G 39524 AV (GB)
ART. M190010

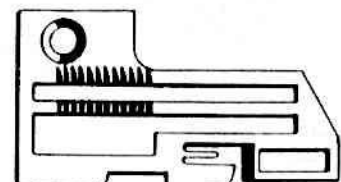

ART. 1180 # G A 39524 AW 5/32" (HH)
ART. M190012



ART. 6775
39505 P (J)



ART. 6786
39526 P

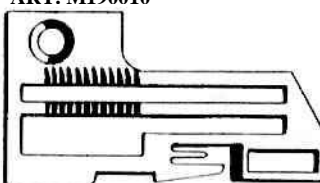

ART. 1178 # G 39524 AW (GC)
GB 39524 AW (HN)
ART. M190011

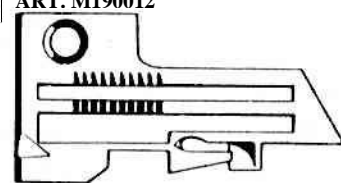

ART. 1195 # A 99531 1/8" (HV 1/8")
ART. M190023



Stichplatten und Transporteure für UNION SPECIAL (needle plates and feed dog for UNION SPECIAL)

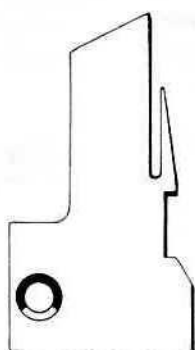

ART. M190007
39524 AB 1/8" (AX 1/8")
ohne Transporteurschlitz

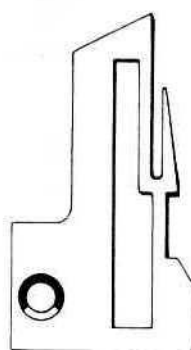

ART. M190008
39524 AB 1/8" (AX 1/8")

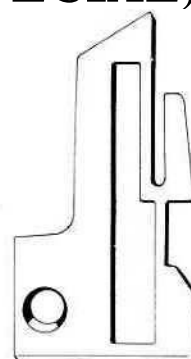

ART. M190009
39524 AB 5/32" (AX 5/32")

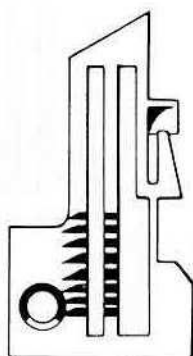

ART. M190022
39524 C 1/8" (AC 1/8")

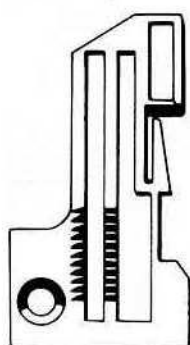

ART. M190024
GA 39524 C 3/32" (HA)

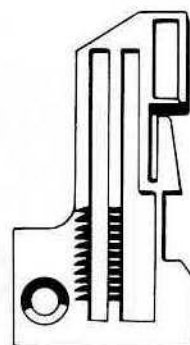

ART. M190025
GA 39524 C 1/8" (HB)

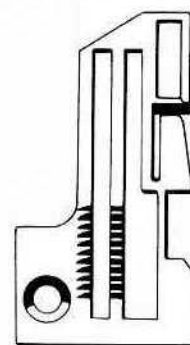

ART. M190026
GA 39524 C 5/32" (HC)

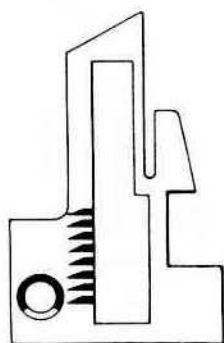

ART. M190027
39524 J

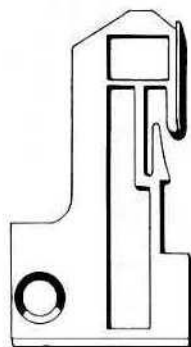

ART. M190028
39524 JU (GI)

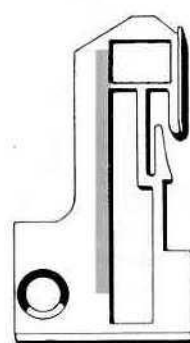

ART. M190038
39524 JU (HE)

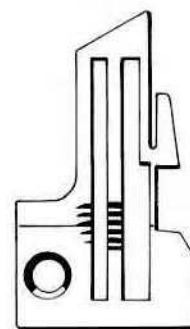

ART. M190029
39524 D (AM)

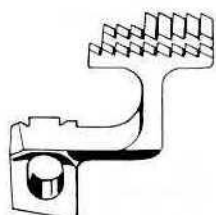

ART. M190018
39526 AW

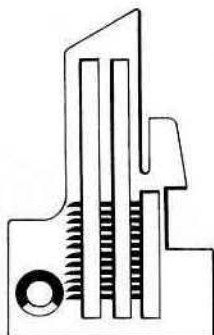

ART. M190031
39524 N (AH)

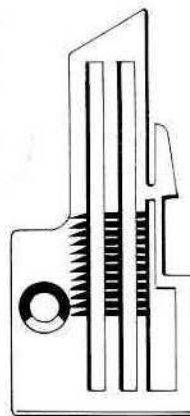

ART. M190032
39524 BF 1/8" (BK)

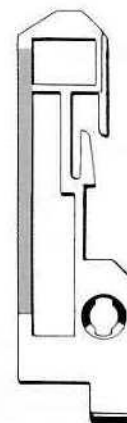

ART. M190033
A 9608 B (HG)

Stichplatten und Transporteure für UNION SPECIAL (needle plates and feed dog for UNION SPECIAL)

Kl. 39500 (cl. 39500)

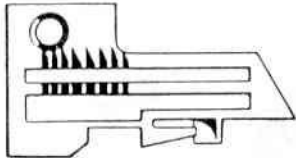

ART. 1235/1 # 39524 AC 1/8" (39524 C 1/8")

ART. M190040 # 39524 AC 1/8" (39524 C 1/8")

ART. 1235/2 # 39524 AC 3/32" (39524 C 3/32")



ART. 2891
39505 B



ART. 2893
39526 B



ART. 2890
39505 C

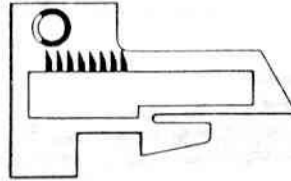

ART. 1240/1 # 39524 J 1/8"

ART. 1240/2 # 39524 J 3/16"

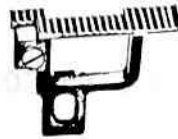

ART. 6771
39505 J/K komplett (complete)

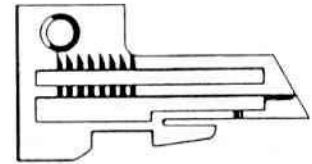

ART. 1183 # 39524 B 3/32" (3/32")

ART. 1188 # 39524 B 1/8" (V 1/8")

ART. 1190 # 39524 B 5/32" (BH)



ART. 2891
39505 B



ART. 2893
39526 B



ART. M190042
39505 B



ART. 2892
39505



ART. M190044

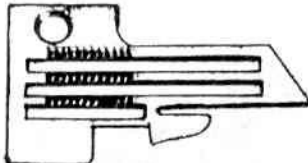

ART. 1250 # 39524 AH (39524 N)

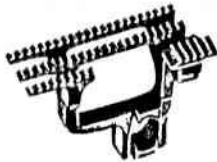

ART. 6772
39505 N/U komplett (complete)

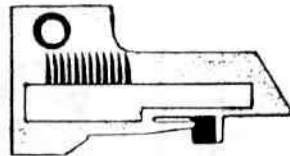

ART. 1150 # 39524 AS

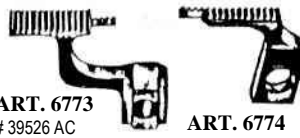

ART. 6773
39526 AC



ART. 6774
39505 AC

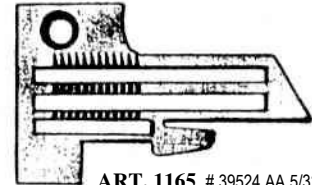

ART. 1165 # 39524 AA 5/32"



ART. 6775
39505 P (J)



ART. 6777
39526 AA (AA)



ART. 6776
39505 E

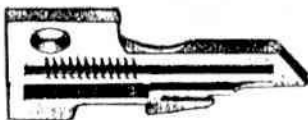

ART. 1153 - # 39524 Y 1/8" (AS)



ART. 6775
39505 P (J)



ART. 6780
39526 Y (AB)



ART. 6776
39505 E

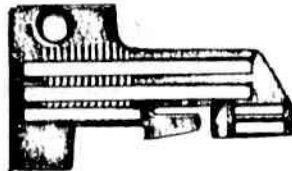

ART. 6778 # 39524 T (AL)



ART. 6782
39526 U (P)



ART. 6781
39505 S (R)

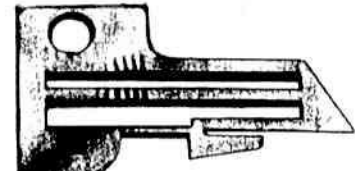

ART. 6779 # 39524 D (AM)



ART. 6783
39505 F (F)



ART. 6785
39526 H

ART. 6784
39505 H (U)

Stichplatten und Transporteure für UNION SPECIAL (needle plates and feed dog for UNION SPECIAL)

Kl. 39500 (cl. 39500)

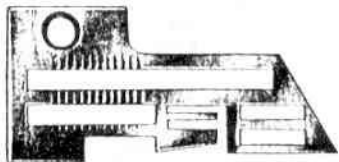

ART. 1281 # 39524 W

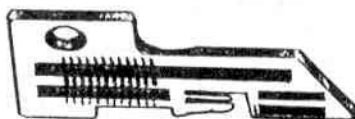

ART. 1282 # 39524 Z



ART. 6871
39505 W



ART. 6872
39526 W

Kl. 52800 (cl. 52800)



ART. 6878 # 52824F-8
ART. 6879 # 52824F-12

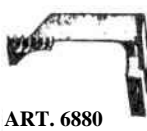

ART. 6880
5026 A

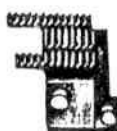

ART. 6881
52805F-8

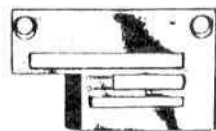

ART. 6878 # 52824F-8

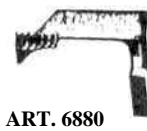

ART. 6880
5026 A

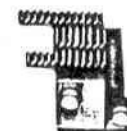

ART. 6881
52805F-8

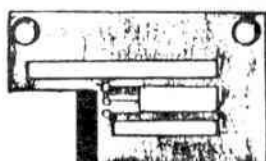

ART. 6888 # 52824K-16



ART. 6889
52826 K



ART. 6890
52805 K



ART. 6893 # 52824X-16



ART. 6894
52805X-16



ART. 6895
3026 A

Kl. 53100 (cl. 53100)

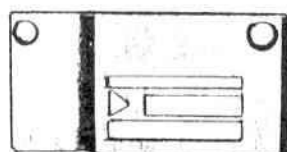

ART. 6914 # 53124 B



ART. 6915
53105 B

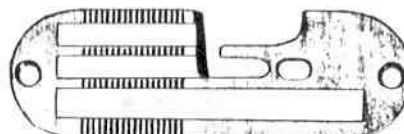

ART. 6919 # 81224 I



ART. 6920 # 81205 A

Kl. 81200 (cl. 81200)

Stichplatten und Transporteure für YAMATO (needle plates and feed dog for YAMATO)

Kl. DCZ-200; 300; 400 (cl. DCZ-200; 300; 400)

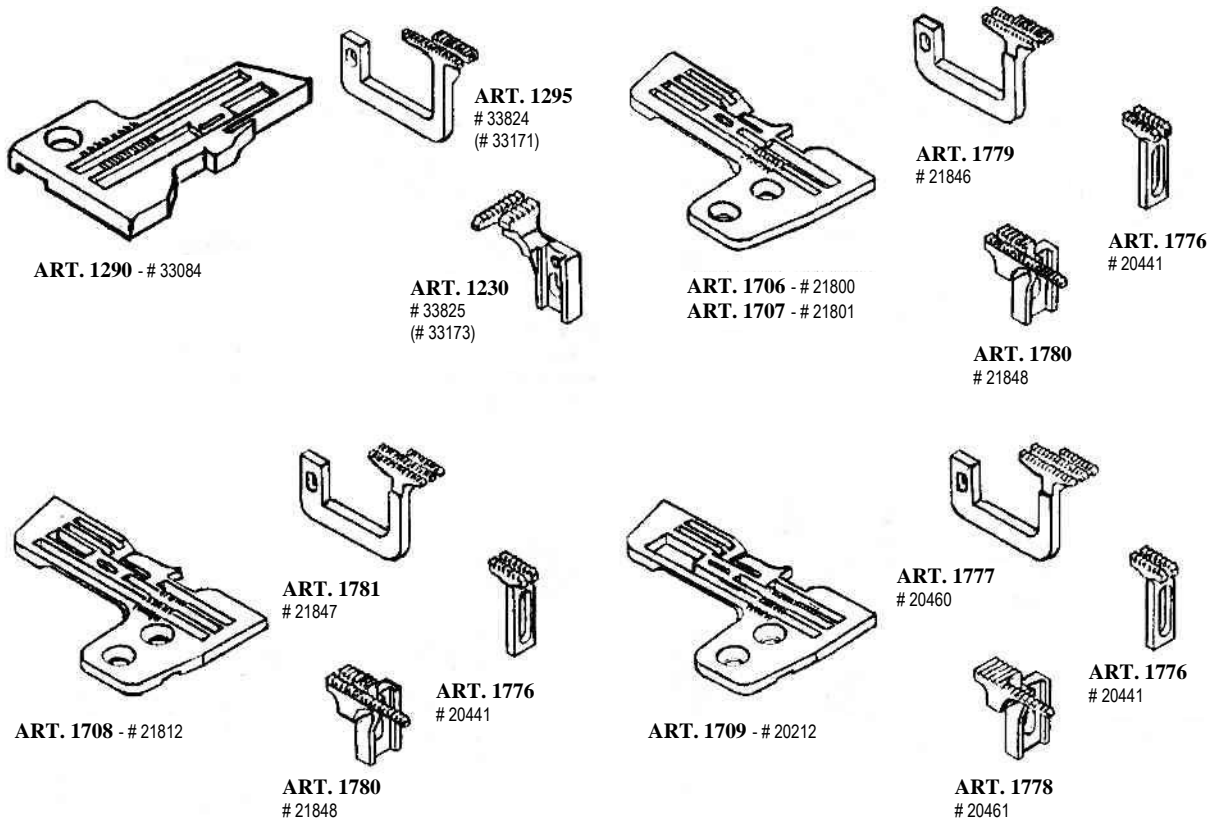

Kl. AZ-6000; AZ-8000
(cl. AZ-6000; AZ-8000)

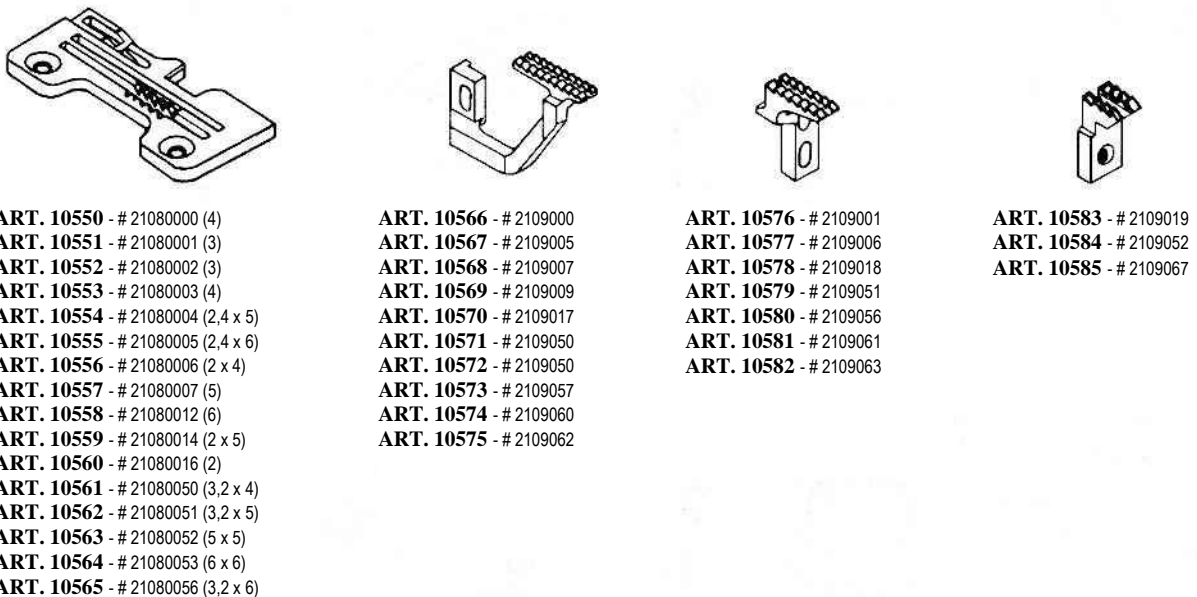

Stichplatten und Transporteure für YAMATO (needle plates and feed dog for YAMATO)

Kl. DCZ-200; 300; 400 (cl. DCZ-200; 300; 400)

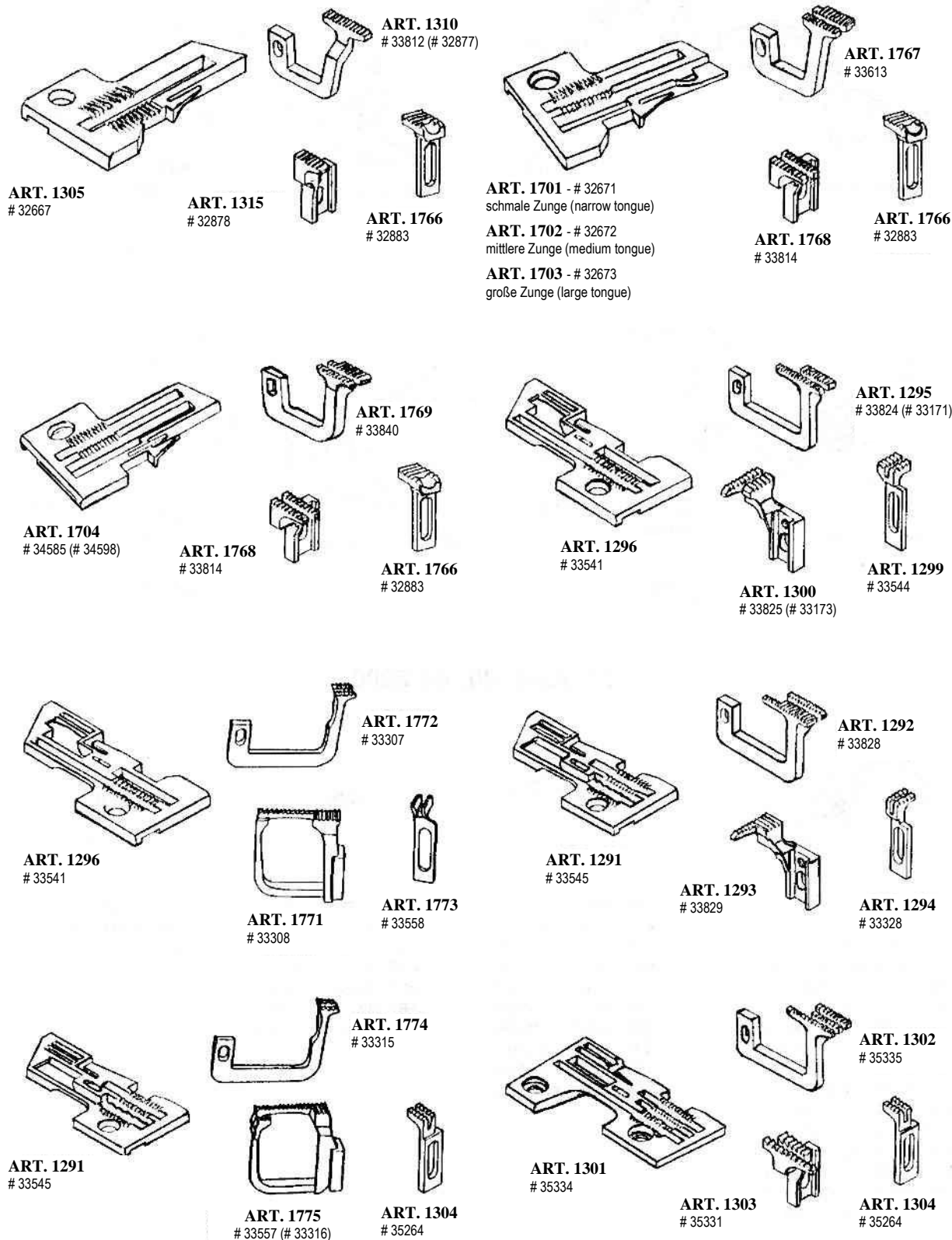

Stichplatten und Transporteure für YAMATO

(needle plates and feed dog for YAMATO)

Kl. DV-100; 300 DW-1350 (cl. DV-100; 300 DW-1350)

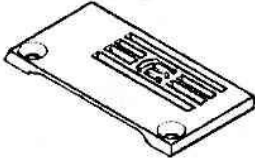

ART. 1711 - # 90166 - 7/32"
ART. 1712 - # 90167 - 1/4"



ART. 1782 - # 90625 - 7/32"
ART. 1783 - # 90632 - 1/4"

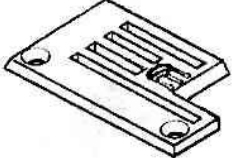

ART. 1718 - # 91764 - 7/32"
ART. 1719 - # 91765 - 1/4"



ART. 1792
91728



ART. 1784 - # 90824 - 7/32"
ART. 1786 - # 90834 - 1/4"



ART. 1793
91729

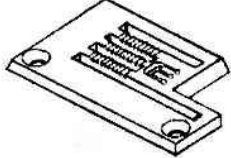

ART. 1721 - # 92152 - 7/32"
ART. 1722 - # 92153 - 1/4"



ART. 1796
92146

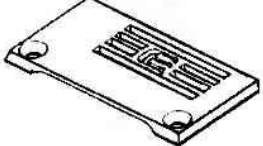

ART. 1713 - # 90553 - 7/32"
ART. 1714 - # 90554 - 1/4"



ART. 1782 - # 90625 - 7/32"
ART. 1783 - # 90632 - 1/4"



ART. 1797
92145



ART. 1787 - # 90624 - 7/32"
ART. 1788 - # 90634 - 1/4"



ART. 1792 - # 91728 - 7/32"
ART. 1794 - # 91760 - 1/4"

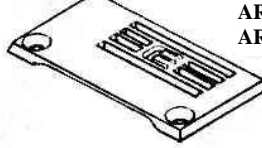

ART. 1798 - # 93394 - 7/32", 3/16"
ART. 1799 - # 93396 - 1/4"

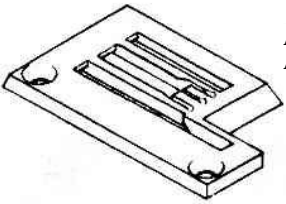

ART. 1716 - # 90556 - 7/32"
ART. 1717 - # 90557 - 1/4"

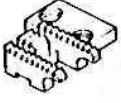

ART. 1789 - # 90232 - 7/32"
ART. 1791 - # 90233 - 1/4"

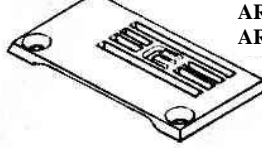

ART. 1191 - # 94800 - 3/16"
ART. 1726 - # 94801 - 7/32"
ART. 1727 - # 94802 - 1/4"



ART. 1800 - # 93395 - 7/32", 3/16"
ART. 1801 - # 93397 - 1/4"

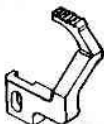

ART. 1802 - # 94230 - 7/32"
ART. 1803 - # 94232 - 1/4"

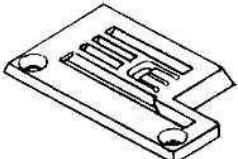

ART. 1723 - # 94901 - 7/32"
ART. 1724 - # 94902 - 1/4"

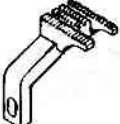

ART. 1804 - # 94231 - 7/32"
ART. 1806 - # 94233 - 1/4"

Weitere YAMATO Stichplatten, ohne Abbildung
(other YAMATO needle plates not shown)

ART. 1728 - # 25010	ART. 1733 - # 34564	ART. 1734 - # 34565
ART. 1732 - # 33543	ART. 1742 - # 34567	ART. 1743 - # 34600
ART. 1744 - # 34671	ART. 1746 - # 34892	ART. 1747 - # 34894
ART. 1748 - # 35355	ART. 1749 - # 90621	ART. 1751 - # 93170
ART. 1752 - # 93171	ART. 1753 - # 94281	ART. 1754 - # 94282
ART. 1756 - # 94921	ART. 1757 - # 94922	ART. 1758 - # 95260
ART. 1759 - # 95261	ART. 1761 - # 95278	ART. 1762 - # 95279
ART. 1729 - # 25011	ART. 1731 - # 33540	

Weitere YAMATO Transporteure, ohne Abbildung
(other YAMATO feed dog not shown)

ART. 1807 - # 20462	ART. 1808 - # 21849	ART. 1809 - # 21850
ART. 1811 - # 25013	ART. 1812 - # 25014	ART. 1813 - # 25015
ART. 1814 - # 25016	ART. 1816 - # 25017	ART. 1817 - # 33830
ART. 1818 - # 33831	ART. 1819 - # 34851	ART. 1821 - # 94260
ART. 1822 - # 94261		

